

ReWaRD

Version 2.5

Reference Manual

RETAINING WALL DESIGN

Information in this document is subject to change without notice and does not represent a commitment on the part of Geocentrix Ltd. The software described in this document is furnished under a licence agreement or non-disclosure agreement and may be used or copied only in accordance with the terms of that agreement. It is against the law to copy the software except as specifically allowed in the licence or non-disclosure agreement. No part of this manual may be reproduced or transmitted in any form or by any means, electronic or mechanical, including photocopying and recording, for any purpose, without the express written permission of Geocentrix Ltd.

©1992-2001 Geocentrix Ltd. All rights reserved.

Geocentrix and ReWaRD are registered trademarks of Geocentrix Ltd.

Frodingham and Larssen are registered trademarks of Corus plc in the United Kingdom.

Microsoft and Windows are registered trademarks of Microsoft Corporation. IBM is a registered trademark of International Business Machines Corp. Other brand or product names are trademarks or registered trademarks of their respective holders

Set in Optimum using Corel WordPerfect 8.0.

Service Release 2.55 (4/01).

Printed in the UK.

Acknowledgments

ReWaRD 2.5 was designed and written by Dr Andrew Bond and Ian Spencer of Geocentrix Ltd. The program was originally commissioned by British Steel Ltd.

The *ReWaRD Reference Manual* was written by Dr Andrew Bond.

Parts of ReWaRD were developed with the assistance of Professor David Potts of Imperial College of Science, Technology, and Medicine and Dr Hugh St John of the Geotechnical Consulting Group.

The following people assisted with the testing of this and previous versions of the program: Vassilis Pouloupoulos (Geocentrix); Romain Arnould (Geotechnical Consulting Group); Andy Fenlon (Nonsuch Videographics); Joe Emmerson (British Steel); and Kieran Dineen (Imperial College).

Table of contents

| | |
|---|-----------|
| Acknowledgments | 3 |
| Table of contents | 5 |
| Chapter 1 | |
| Introduction | 9 |
| About this book | 9 |
| Conventions | 10 |
| Where to go for help | 11 |
| User manual | 11 |
| Reference manual | 11 |
| On-line help | 11 |
| Tooltips | 11 |
| Technical support | 12 |
| Sales and marketing information | 12 |
| Chapter 2 | |
| Earth pressures | 13 |
| Earth pressure conditions | 13 |
| Earth pressures as built | 14 |
| Earth pressures at minimum safe embedment | 14 |
| Earth pressures with maximum safety factors | 14 |
| Earth pressures at failure | 14 |
| Stresses in the ground | 15 |
| Total or effective stresses? | 15 |
| Vertical total stress | 15 |
| Pore water pressure | 16 |
| Vertical effective stress | 17 |
| Horizontal effective stress | 17 |
| Horizontal total stress | 18 |
| Pressures from surcharges | 19 |
| Available calculation methods | 19 |
| Uniform surcharges | 20 |
| Parallel strip surcharges | 20 |
| Perpendicular strip surcharges | 24 |
| Parallel line surcharges | 25 |
| Perpendicular line surcharges | 29 |

| | |
|-------------------------------------|-----------|
| Area surcharges | 30 |
| Point surcharges | 32 |
| Design pressures | 34 |
| Soil pressures | 34 |
| Surcharge pressures | 35 |
| Combined earth pressures | 35 |
| Groundwater pressures | 36 |
| Tension cracks | 36 |
| Combined water pressures | 38 |
| Total pressures | 38 |
| Minimum active pressures | 38 |
| Low-propped walls | 38 |
| Earth pressure coefficients | 41 |
| Coulomb | 41 |
| Rankine | 42 |
| Packshaw | 43 |
| Caquot & Kerisel | 43 |
| Kerisel & Absi | 44 |
| | |
| Chapter 3 | |
| Required embedment | 45 |
| Out-of-balance moment | 45 |
| Cantilever walls | 45 |
| Fixed-earth conditions | 45 |
| Single-propped walls | 46 |
| Free-earth conditions | 46 |
| Multi-propped walls | 47 |
| | |
| Chapter 4 | |
| Structural forces | 49 |
| Cantilever and single-propped walls | 49 |
| At minimum safe embedment | 49 |
| With maximum safety factors | 49 |
| At failure | 50 |
| Multi-propped walls | 51 |
| Design structural forces | 52 |
| Bending moments | 52 |
| Shear forces | 52 |
| Prop forces | 52 |
| | |
| Chapter 5 | |

| | |
|---|-----------|
| Peck's envelopes | 53 |
| Distributed prop loads | 53 |
| Peck's envelopes | 53 |
| Envelope for sand | 54 |
| Envelope for stiff clay | 54 |
| Envelope for soft to medium clays | 55 |
| Obtaining prop loads from Peck's envelopes | 56 |
| | |
| Chapter 6 | |
| Base stability | 57 |
| Factor-of-safety against basal heave | 57 |
| Stability number | 57 |
| Rigid layer correction | 58 |
| | |
| Chapter 7 | |
| Displacements | 59 |
| Database of wall movements | 59 |
| Surcharge loading factor | 60 |
| Database for sands | 60 |
| Cantilever and propped walls | 60 |
| Database for stiff clays | 62 |
| Cantilever walls | 62 |
| Propped walls | 63 |
| Database for soft clays | 65 |
| Cantilever and propped walls | 65 |
| System stiffness | 67 |
| | |
| Chapter 8 | |
| Durability | 69 |
| Corrosion of steel piling in various environments | 69 |
| | |
| Chapter 9 | |
| Safety factors | 71 |
| Design approaches | 71 |
| Safety factors in earth pressure calculations | 72 |
| Gross pressure method | 72 |
| Nett pressure method | 73 |
| Revised (or Burland-Potts) method | 75 |
| Strength factor method | 76 |
| Limit state methods | 77 |
| Safety factors for structural forces | 80 |
| At minimum safe embedment | 80 |

| | |
|-----------------------------------|------------|
| With maximum safety factors | 81 |
| At failure | 81 |
| Chapter 10 | |
| Engineering objects | 83 |
| Construction stages | 83 |
| Ground profiles | 83 |
| Sloping ground | 83 |
| Stepped ground | 83 |
| Excavations | 85 |
| Sloping excavations | 85 |
| Berms | 85 |
| Plan dimensions | 88 |
| Soils | 88 |
| Soil classification system | 88 |
| Database of soil properties | 90 |
| Critical state parameters | 99 |
| Fissured soils | 99 |
| Layers | 100 |
| Dip | 100 |
| Rigid layers | 100 |
| Water tables | 101 |
| Retaining walls | 101 |
| Section properties | 101 |
| Rowe's parameter | 103 |
| King-post (or soldier-pile) walls | 103 |
| Surcharges | 104 |
| Elastic reflection parameter | 104 |
| Duration/effect | 105 |
| Imposed loads | 105 |
| Duration/effect | 105 |
| Chapter 11 | |
| References | 107 |

Chapter 1

Introduction

ReWaRD is an advanced program for designing embedded retaining walls under a variety of ground and loading conditions. The program implements a number of techniques for designing retaining walls, including those given in the latest UK and international standards, such as BS 8002 and Eurocode 7.

This chapter of the *ReWaRD Reference Manual* outlines the contents of this book, explains the conventions that are used herein, and tells you what to do if you need help using the program.

About this book

This *Reference Manual* is divided into the following chapters:

- Chapter 1 *Introduction*
- Chapter 2 *Earth pressures*
- Chapter 3 *Required embedment*
- Chapter 4 *Structural forces*
- Chapter 5 *Peck's envelopes*
- Chapter 6 *Base stability*
- Chapter 7 *Displacements*
- Chapter 8 *Durability*
- Chapter 9 *Safety factors*
- Chapter 10 *Engineering objects*
- Chapter 11 *References*

Conventions

To help you locate and interpret information easily, the *ReWaRD User Manual* uses the following typographical conventions.

| This | Represents |
|----------------------|--|
| Bold | Items on a menu or in a list-box; the text on a button or next to an edit control; or the label of a group box |
| Item1 ▶ Item2 | An item on a cascading menu. Item1 is the name of an option on the main menu bar (such as File or Window); and Item2 is the name of an option on the cascading menu that appears when you select Item1 (such as New or Open). Thus, File ▶ New represents the New command from the File menu. |
| <i>italic</i> | Place holders for information you must provide. For example, if you are asked to type <i>filename</i> , you should type the actual name for a file instead of the word shown in italics |
| | Italic type also signals a new term. An explanation immediately follows the italicized term |
| monospaced | Anything you must type on the keyboard |
| CAPITALS | Directory names, filenames, and acronyms |
| KEY1+KEY2 | An instruction to press and hold down key 1 before pressing key 2. For example, "ALT+ESC" means press and hold down the ALT key before pressing the ESC key. Then release both keys |
| KEY1, KEY2 | An instruction to press and release key 1 before pressing key 2. For example, "ALT, F" means press and release the ALT key before pressing and releasing the F key |

Where to go for help

Your first source of help and information should be the ReWaRD manuals and the on-line help system.

User manual

The *ReWaRD User Manual* explains how to install and use ReWaRD. It includes an overview of the program, a tutorial, and separate chapters giving detailed information about ReWaRD's Stockyard and Workbooks.

Reference manual

The *ReWaRD Reference Manual* (this book) gives detailed information about the calculations ReWaRD performs. The manual assumes you have a working knowledge of the geotechnical design of embedded retaining walls.

On-line help

The on-line help system contains detailed information about ReWaRD. Help appears in a separate window with its own controls. Help topics that explain how to accomplish a task appear in windows that you can leave displayed while you follow the procedure.

To open the on-line help system:

- Press F1
- Click the Help button in a dialogue box
- Choose a command from the **Help** menu

If you need assistance with using on-line help, choose the **How To Use Help** command from the **Help** menu.

Tooltips

If you pause while passing the mouse pointer over an object, such as a toolbar button, ReWaRD displays the name of that object. This feature, called Tooltips, makes it easier for you to identify what you see and to find what you need.

Technical support

Technical support for ReWaRD is available direct from Geocentrix or through your local distributor. If you require technical support, please contact Geocentrix by any of these means:

Voice: +44 (0)1737 373963

Fax: +44 (0)1737 373980

E-mail: support@geocentrix.co.uk

Web: www.geocentrix.co.uk

Please be at your computer and have your licence number ready when you call.

Alternatively, you can write to the following address:

ReWaRD Technical Support
Geocentrix Ltd
Scenic House
54 Wilmot Way
Banstead
Surrey
SM7 2PY
United Kingdom

Please quote your licence number on all correspondence.

Sales and marketing information

For sales and marketing information about ReWaRD, please contact ReWaRD Sales on the same numbers as above.

Chapter 2

Earth pressures

This chapter gives detailed information about the theory and assumptions behind ReWaRD's earth pressure calculations.

In order to calculate earth pressures, ReWaRD divides the ground into a number of discrete *horizons*. Each horizon contains:

- A soil layer (if below ground level on the retained side of the wall or below formation level on the excavated side)
- A maximum of one water table
- A maximum of one prop or anchor
- An unlimited number of surcharges
- An unlimited number of imposed loads

The results of ReWaRD's earth pressure calculations are available at the top and bottom of each horizon and (when present) at any internal *sub-horizons* within the horizon. ReWaRD inserts sub-horizons into an horizon when:

- Earth pressures increase with depth in a non-linear manner (such as when a non-uniform surcharge is applied to the wall)
- Earth pressures are needed for structural force calculations (to ensure sufficient accuracy in the bending moments)

Earth pressure conditions

ReWaRD allows you to calculate earth pressures for a number of conditions:

- As built
- At the minimum safe embedment
- With maximum safety factors
- At failure

The following paragraphs explain the assumptions that are made for each of these conditions and the table below summarizes these.

| Condition | Wall length* | Safety factors** | In equilibrium? |
|-----------------------------|--------------|------------------|-----------------|
| As built | L | γ | No*** |
| At minimum safe embedment | < L | γ | Yes |
| With maximum safety factors | L | $> \gamma$ | Yes |
| At failure | $\ll L$ | 1.0 | Yes |

*L = specified wall length (as used in the construction stage)

** γ = specified safety factor (from the selected design standard)

***Unless the wall length is selected accordingly

Earth pressures as built

ReWaRD calculates as-built earth pressures for the specified wall length and safety factors using limiting earth pressure coefficients. As-built earth pressures are not normally in equilibrium: the wall is either unstable (i.e. has too little embedment) or stable (i.e. has sufficient embedment) at limiting conditions.

Earth pressures at minimum safe embedment

ReWaRD calculates earth pressures at minimum safe embedment by reducing the wall length until the earth pressures are in equilibrium for the specified safety factors, using limiting earth pressure coefficients.

Earth pressures with maximum safety factors

ReWaRD calculates earth pressures with maximum safety factors by increasing the safety factors until the earth pressures are in equilibrium for the specified wall length, using limiting earth pressure coefficients.

Earth pressures at failure

ReWaRD calculates earth pressures at failure by reducing the wall length until the earth pressures are in equilibrium with safety factors set to unity, using limiting earth pressure coefficients.

Stresses in the ground

This section describes the way ReWaRD calculates the stresses acting in the ground, owing to the weight of soil and water:

- Vertical total stress (σ_v)
- Pore water pressure (u)
- Vertical effective stress (σ'_v)
- Horizontal effective stress (σ'_h)
- Horizontal total stress (σ_h)

Total or effective stresses?

The following table indicates when ReWaRD calculates earth pressures using total stress or effective stress theory.

| Construction stage designated as... | Type of layer... | |
|-------------------------------------|------------------|------------------|
| | Drained | Undrained |
| Short-term | Effective stress | Total stress |
| Long-term | Effective stress | Effective stress |

Vertical total stress

The vertical total stress in an horizon (σ_v) is calculated from the unit weight and thickness of any soil layers and standing water above the point being considered:

$$\sigma_v = \int_0^z \gamma \, dz + \gamma_w h_{sw}$$

where z is the depth below the ground surface; γ is the layer's bulk unit weight; γ_w is the unit weight of water; and h_{sw} is the height of any standing water.

When there is no water table acting in the horizon or the water table is Dry, γ is equal to the soil's *unsaturated* unit weight; otherwise it is equal to the soil's *saturated* unit weight.

Pore water pressure

Drained horizons

The pore water pressure (u) at a depth (z) in a drained horizon is calculated as follows.

If no water table is present or the water table is dry:

$$u = 0$$

If a water table is present and it is hydraulically connected to the overlying water regime:

$$u = u_T + \left(\frac{\partial u}{\partial z}\right)(z - z_T)$$

where u_T and z_T are the pore water pressure and depth (respectively) at the top of the horizon; and $\partial u/\partial z$ is the pore pressure gradient.

If a water table is present but it is *not* hydraulically connected to the overlying water regime:

$$u = u_A + \left(\frac{\partial u}{\partial z}\right)(z - z_W)$$

where u_A is the ambient pore water pressure specified by the water table; z_W is the depth of the water table; and $\partial u/\partial z$ is the pore pressure gradient.

The value of $\partial u/\partial z$ is determined by the type of water table present in the horizon (see on-line Help).

Undrained horizons

The pore water pressure in undrained horizons is calculated as for drained horizons, but it is irrelevant to the calculation of total earth pressures and is therefore not displayed.

Vertical effective stress

Drained horizons

The vertical effective stress in the horizon (σ'_v) is given by Terzaghi's equation:

$$\sigma'_v = \sigma_v - u$$

where σ_v is the vertical total stress and u the pore water pressure at the corresponding depth.

Undrained horizons

The vertical effective stress in undrained horizons is irrelevant to the calculation of total earth pressures and is therefore not displayed.

Horizontal effective stress

Drained horizons

The horizontal effective stress in a drained horizon (σ'_h) is obtained from the vertical effective stress (σ'_v) via the equation:

$$\sigma'_h = K\sigma'_v - K_c c'$$

where K and K_c are drained earth pressure coefficients and c' is the soil's effective cohesion.

The value of K depends on the soil's angle of friction (ϕ), the angle of wall friction (δ), the dip of the horizon (β) and the mode of failure (active or passive):

$$K = f(\phi, \delta, \beta, \text{mode of failure})$$

See the section *Earth pressure coefficients* in this chapter for details on the precise form of the function f .

K_c depends on the value of K and also the soil's effective cohesion (c'), wall adhesion (a), and the mode of failure:

$$K_c = \pm 2 \sqrt{K \left(1 + \frac{a}{c'}\right)}$$

where the + sign is used for active conditions and the - sign for passive (Potts & Burland, 1983).

If the retaining wall is a king-post wall, then the earth pressure coefficients below formation level on the excavated side of the wall are calculated as described in Chapter 10 in the section entitled *Retaining Walls*.

Undrained horizons

The horizontal effective stress in undrained horizons is irrelevant to the calculation of total earth pressures and is not displayed.

Horizontal total stress

Drained horizons

In drained horizons, the horizontal total stress (σ_h) is given by Terzaghi's equation:

$$\sigma_h = \sigma'_h + u$$

where σ'_h is the horizontal effective stress and u the pore water pressure at the corresponding depth.

Undrained horizons

In undrained horizons, the horizontal total stress (σ_h) is given by:

$$\sigma_h = K_u \sigma_v - K_{uc} C_u$$

where K_u and K_{uc} are undrained earth pressure coefficients and C_u the soil's undrained shear strength.

The value of K_u is 1 in all cases, whereas the value of K_{uc} depends on the soil's undrained strength (C_u), the undrained wall adhesion

(a_u), and the mode of failure (active or passive):

$$K_{uc} = \pm 2 \sqrt{1 + \frac{a_u}{C_u}}$$

where the + sign is used for active conditions and the – sign for passive.

If the retaining wall is a king-post wall, then the earth pressure coefficients below formation level on the excavated side of the wall are calculated as described Chapter 10 in the section entitled *Retaining Walls*.

Pressures from surcharges

This section describes the way ReWaRD calculates earth pressures arising from the presence of surcharges.

Available calculation methods

ReWaRD supports a number of methods for assessing the effects of surcharges, as listed below:

- Boussinesq's theory (see Clayton & Militiski, 1986) [B]
- Hybrid elastic method (*ibid.*) [HE]
- Wedge analysis (see Pappin *et al.*, 1985) [W]
- Krey's method¹ (British Steel Piling Handbook, 1988) [K]
- Terzaghi's method (see CIRIA 104, 1984) [T]

Not every method can be used with every surcharge, as the following table indicates (in this table, the headings correspond to the letters given above in square brackets).

| Surcharge type | B | HE | W | K | T |
|----------------|---------------------------|----|---|---|---|
| Uniform | Special method not needed | | | | |

soils

¹Recommended for cohesionless, but not necessarily for cohesive,

| Surcharge type | B | HE | W | K | T |
|---------------------|---|----|---|---|---|
| Area | ✓ | ✓ | ✓ | ✓ | |
| Parallel strip | ✓ | ✓ | ✓ | ✓ | |
| Perpendicular strip | ✓ | ✓ | | | |
| Parallel line | ✓ | ✓ | ✓ | ✓ | ✓ |
| Perpendicular line | ✓ | ✓ | | | |
| Point | ✓ | ✓ | | | ✓ |

Uniform surcharges

The vertical stress resulting from a uniform surcharge (q) is given by:

$$\sigma_{vq} = q$$

For cantilever and high-propped walls, the corresponding horizontal stress is:

$$\sigma_{hq} = K_a q$$

When the wall is low-propped, $\sigma_{hq} = K_a q$ for depths *above* the level of the prop (or equivalent single-prop) and:

$$\sigma_{hq} = K_i q$$

for depths *below* the level of the prop.

Parallel strip surcharges

ReWaRD provides four methods of calculating the effects of parallel strip surcharges.

Boussinesq's theory

The vertical and horizontal stresses resulting from a parallel strip surcharge of magnitude q are calculated from the equations:

$$\sigma_{vq} = \frac{q}{\pi} [\alpha + \sin\alpha \cos(\alpha + 2\theta)] e_R$$

$$\sigma_{hq} = \frac{q}{\pi} [\alpha - \sin\alpha \cos(\alpha + 2\theta)] e_R$$

where $\tan(\alpha + \theta) = (x + y)/z$; $\tan \theta = x/z$; e_R is the elastic reflection parameter (see the section entitled *Surcharges* in Chapter 10); z is the depth below the surcharge; x is the perpendicular distance between the wall and the nearest edge of the surcharge; and y is the width of the surcharge.

Hybrid elastic method

The vertical stress is calculated from Boussinesq's theory and the horizontal stress is given by:

$$\sigma_{hq} = K_a \sigma_{vq}$$

where K_a is the active earth pressure coefficient for the horizon.

Wedge analysis

The horizontal stress is calculated from plasticity theory, assuming zero wall friction and adhesion.

The horizontal stress depends on the width of the surcharge. A strip surcharge is considered *wide* if:

$$\frac{2y}{x} \geq 1 + \tan^2 \left(45^\circ - \frac{\phi}{2} \right)$$

otherwise it is *narrow*. In this equation, x is the perpendicular distance between the wall and the nearest edge of the surcharge; y is the width of the surcharge; and ϕ is the soil's angle of friction.

The horizontal stress varies with depth below the surcharge (z) as shown below.

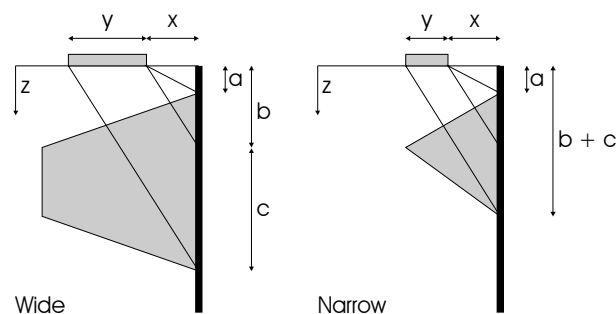

For *wide* strip surcharges, the *maximum* horizontal stress is given by:

$$(\sigma_{hq})_{\max} = q \tan^2 \left(45^\circ - \frac{\phi}{2} \right)$$

and for *narrow* strip surcharges, it is given by:

$$(\sigma_{hq})_{\max} = \frac{4 q \tan^2 \left(45^\circ - \frac{\phi}{2} \right)}{2 + \frac{x}{y} \left[1 + \tan^2 \left(45^\circ - \frac{\phi}{2} \right) \right]}$$

The vertical stress for both *wide* and *narrow* strip surcharges is assumed to be:

$$\sigma_{vq} = \frac{\sigma_{hq}}{\tan^2(45^\circ - \frac{\phi}{2})}$$

The dimensions a , b , and c on these diagrams are given by:

$$a = x \tan \phi = \frac{1}{2} b (1 - \tan^2(45^\circ - \frac{\phi}{2}))$$

$$b = \frac{x}{\tan(45^\circ - \frac{\phi}{2})}$$

$$c = \frac{y}{\tan(45^\circ - \frac{\phi}{2})}$$

Krey's method

The horizontal stress is calculated from plasticity theory, assuming zero wall friction and adhesion.

The horizontal stress varies with depth below the surcharge (z) as shown below.

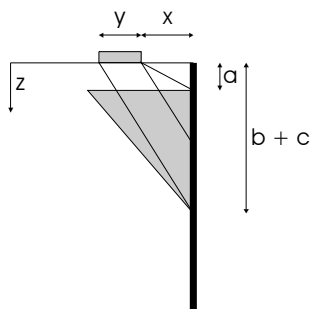

The *maximum* horizontal stress is given by:

$$(\sigma_{hq})_{\max} = \frac{4 q \tan^2 \left(45^\circ - \frac{\phi}{2}\right)}{2 + \frac{x}{y} \left[1 + \tan^2 \left(45^\circ - \frac{\phi}{2}\right)\right]}$$

The dimensions a , b , and c on this diagram are the same as for the Wedge analysis.

The vertical stress is assumed to be:

$$\sigma_{vq} = \frac{\sigma_{hq}}{\tan^2 \left(45^\circ - \frac{\phi}{2}\right)}$$

Perpendicular strip surcharges

ReWaRD provides two methods of calculating the effects of perpendicular strip surcharges.

Boussinesq's theory

The vertical and horizontal stresses resulting from a perpendicular strip surcharge of magnitude q are calculated from the equations:

$$\sigma_{vq} = \frac{q}{\pi} [\alpha + \sin \alpha \cos (\alpha + 2\theta)]$$

$$\sigma_{hq} = 2q\nu \frac{\alpha}{\pi}$$

where $\tan (\alpha + \theta) = (x + y)/z$; $\tan \theta = x/z$; z is the depth below the surcharge; x is the distance along the wall to the nearest edge of the surcharge; y is the width of the surcharge; and ν is Poisson's ratio.

Hybrid elastic method

The vertical stress is calculated from Boussinesq's theory, and the horizontal stress is given by:

$$\sigma_{hq} = K_a \sigma_{vq}$$

where K_a is the active earth pressure coefficient for the horizon.

Parallel line surcharges

ReWaRD provides five methods of calculating the effects of parallel line surcharges.

Boussinesq's theory

The vertical and horizontal stresses resulting from a perpendicular line surcharge of magnitude Q are calculated from the equations:

$$\sigma_{vq} = 2Q \frac{z^3}{\pi R^4} e_R$$

$$\sigma_{hq} = 2Q \frac{x^2 z}{\pi R^4} e_R$$

where $R^2 = x^2 + z^2$; e_R is the elastic reflection parameter (see the section entitled *Surcharges* in Chapter 10); z is the depth below the surcharge; and x is the perpendicular distance between the wall and the surcharge.

Hybrid elastic method

The vertical stress is calculated from Boussinesq's theory, and the horizontal stress is given by:

$$\sigma_{hq} = K_a \sigma_{vq}$$

where K_a is the active earth pressure coefficient for the horizon.

Wedge analysis

The horizontal stress is calculated from plasticity theory, assuming zero wall friction and adhesion.

The horizontal stress varies with depth below the surcharge (z) as shown below.

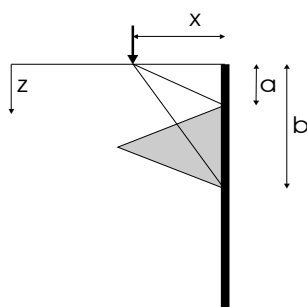

The *maximum* horizontal stress is given by:

$$(\sigma_{hq})_{\max} = \frac{4 Q \tan^2 (45^\circ - \frac{\phi}{2})}{x [1 + \tan^2 (45^\circ - \frac{\phi}{2})]}$$

The dimensions a and b are as defined for parallel strip surcharges.

The vertical stress is assumed to be:

$$\sigma_{vq} = \frac{\sigma_{hq}}{\tan^2(45^\circ - \frac{\phi}{2})}$$

Krey's method

In this method, the horizontal total stress increase is calculated from plasticity theory, assuming zero wall friction and adhesion.

The horizontal stress varies with depth below the surcharge (z) as shown below.

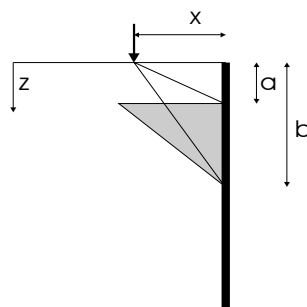

The *maximum* horizontal stress is given by:

$$(\sigma_{hq})_{\max} = \frac{4 Q \tan^2 (45^\circ - \frac{\phi}{2})}{x [1 + \tan^2 (45^\circ - \frac{\phi}{2})]}$$

The dimensions a and b are the same as for parallel strip surcharges.

The vertical stress is assumed to be:

$$\sigma_{vq} = \frac{\sigma_{hq}}{\tan^2(45^\circ - \frac{\phi}{2})}$$

Terzaghi's method

Terzaghi's method is based on elasticity theory, modified to match field and model experiments.

The vertical stress is calculated from Boussinesq's theory.

The horizontal stress depends on the proximity of the surcharge to the retaining wall. A line surcharge is considered *near* to the wall if:

$$\frac{x}{H} \leq 0.4$$

otherwise it is *far* from the wall. In this equation, x is the perpendicular distance between the wall and the surcharge; and H is the height of excavation below the surcharge.

For *near* line surcharges, the horizontal stress varies with depth below the surcharge (z) according to the formula:

$$\sigma_{hq} = 0.20 \frac{Q}{H} \frac{\left(\frac{Z}{H}\right)}{\left(0.16 + \left[\frac{Z}{H}\right]^2\right)^2}$$

For *far*line surcharges, the horizontal stress varies with depth below the surcharge according to the formula:

$$\sigma_{hq} = 1.28 \frac{Q}{H} \frac{\left(\frac{X}{H}\right)^2 \left(\frac{Z}{H}\right)}{\left(\left[\frac{X}{H}\right]^2 + \left[\frac{Z}{H}\right]^2\right)^2}$$

Perpendicular line surcharges

ReWaRD provides two methods of calculating the effects of perpendicular line surcharges.

Boussinesq's theory

The vertical and horizontal total stresses resulting from a perpendicular line surcharge of magnitude Q are calculated from the equations:

$$\Delta\sigma_{vq} = 2Q \frac{z^3}{\pi R^4}$$

$$\Delta\sigma_{hq} = 2Q \frac{z}{\pi R^2} \nu$$

where $R^2 = x^2 + z^2$; z is the depth below the surcharge; x is the distance along the wall to the surcharge; and ν is Poisson's ratio.

Hybrid elastic method

The vertical stress is calculated from Boussinesq's theory and the horizontal stress is given by:

$$\sigma_{hq} = K_a \sigma_{vq}$$

where K_a is the active earth pressure coefficient for the horizon.

Area surcharges

ReWaRD provides four methods of calculating the effects of area surcharges.

Boussinesq's theory

The vertical and horizontal stresses resulting from an area surcharge of magnitude q are calculated from the equations:

$$\sigma_{vq} = \frac{q}{2\pi} \left[\tan^{-1}\left(\frac{LB}{zR}\right) + \frac{zLB}{R} \left(\frac{1}{R_L^2} + \frac{1}{R_B^2} \right) \right] e_R$$

$$\sigma_{hq} = \frac{q}{2\pi} \left[\tan^{-1}\left(\frac{LB}{zR}\right) - \frac{zLB}{R} \left(\frac{1}{R_L^2} \right) \right] e_R$$

where z is the depth below the corner of a rectangular loaded area of length L and breadth B ; $R^2 = z^2 + L^2 + B^2$; $R_L^2 = z^2 + L^2$; $R_B^2 = z^2 + B^2$; and e_R is elastic reflection parameter (see the section entitled *Surcharges* in Chapter 10).

The effect of an area surcharge which is offset from the wall is calculated by superimposing the following surcharges:

- Add stress from area surcharge with $B = x + y$, $L = v + w$
- Deduct stress from area surcharge with $B = x$, $L = v + w$
- Deduct stress from area surcharge with $B = x + y$, $L = v$
- Add stress from area surcharge with $B = x$, $L = v$

where x is the perpendicular distance between the wall and the nearest edge of the surcharge; y is the breadth of the surcharge perpendicular to the wall; v is the distance parallel to the wall between the cross-section being considered and the nearest edge of the surcharge; and w is the length of the surcharge parallel to the wall.

Hybrid elastic method

The vertical stress is calculated from Boussinesq's theory and the horizontal stress is given by:

$$\sigma_{hq} = K_a \sigma_{vq}$$

where K_a is the active earth pressure coefficient.

Krey's method and Wedge analysis

In both these methods, the horizontal stress is calculated for a strip surcharge running parallel to the wall, and is then reduced to account for the finite length of the surcharge.

For $v \leq x$:

$$(\sigma_{hq})_{AREA} = (\sigma_{hq})_{STRIP} \div \left(\frac{2x}{w} + 1 \right)$$

where v , x , and w are as defined above.

For $v > x$:

$$(\sigma_{hq})_{AREA} = 0$$

The vertical stress is assumed to be:

$$\sigma_{vq} = \frac{\sigma_{hq}}{\tan^2(45^\circ - \frac{\phi}{2})}$$

Point surcharges

ReWaRD provides three methods of calculating the effects of area surcharges.

Boussinesq's theory

The vertical and horizontal stresses resulting from a point surcharge of magnitude P are calculated from the equations:

$$\sigma_{vq} = \frac{3}{2} \frac{P z^3}{\pi R^5} e_R$$

$$\sigma_{hq} = \frac{P}{2\pi R^2} \left[\frac{3z(v^2 + x^2)}{R^3} - (1 - 2\nu) \frac{R}{(R + z)} \right] e_R$$

where $R^2 = v^2 + x^2 + z^2$; e_R is elastic reflection parameter (see the section entitled *Surcharges* in Chapter 10); z is the depth below the surcharge; v is the distance along the wall to the surcharge; x is the perpendicular distance between the wall and the surcharge; and ν is Poisson's ratio.

Hybrid elastic method

The vertical stress is calculated from Boussinesq's theory, and the horizontal stress is given by:

$$\sigma_{hq} = K_a \sigma_{vq}$$

where K_a is the active earth pressure coefficient.

Terzaghi's method

Terzaghi's method is based on elasticity theory, modified to match field and model experiments.

The vertical stress is calculated from Boussinesq's theory.

The horizontal stress depends on the proximity of the surcharge to the retaining wall. A point surcharge is considered *near* to the wall if:

$$\frac{x}{H} \leq 0.4$$

otherwise it is *far* from the wall. In this equation, x is the perpendicular distance between the wall and the surcharge; and H is the height of the excavation below the surcharge.

For *near* point surcharges, the horizontal stress varies with depth below the surcharge (z) according to the formula:

$$\sigma_{hq} = 0.28 \frac{P}{H^2} \frac{\left(\frac{z}{H}\right)^2}{\left(0.16 + \left[\frac{z}{H}\right]^2\right)^3} \cos^2(1.1\Theta)$$

For *far* point surcharges, the horizontal stress varies with depth according to the formula:

$$\sigma_{hq} = 1.77 \frac{P}{H^2} \frac{\left(\frac{x}{H}\right)^2 \left(\frac{z}{H}\right)^2}{\left(\left[\frac{x}{H}\right]^2 + \left[\frac{z}{H}\right]^2\right)^3} \cos^2(1.1\Theta)$$

In these equations, $\Theta = \tan^{-1}(v/x)$, where v is the distance along the

wall to the surcharge.

Design pressures

Design pressures acting on the wall are obtained from the series of calculations described below. Appropriate safety factors (see Chapter 9) are included in these calculations depending on which design standard is selected.

Soil pressures

Earth pressures resulting from the weight of soil alone are termed *soil pressures* in ReWaRD and given the symbol E_s .

Drained horizons

Unfactored soil pressures in drained horizons are given by:

$$E_s = \sigma'_h$$

where σ'_h is the horizontal effective stress in the soil.

Design soil pressures are given by:

$$E_{sd} = \frac{E_s}{f_{Es}}$$

where f_{Es} is the appropriate safety factor for the selected design standard (see Chapter 9).

Undrained horizons

Unfactored soil pressures in undrained horizons are given by:

$$E_s = \sigma_h$$

where σ_h is the horizontal total stress in the soil.

Design soil pressures are obtained in the same way as for drained

horizons.

Surcharge pressures

Earth pressures resulting from the presence of surcharges alone are termed *surcharge pressures* in ReWaRD and given the symbol E_q .

Unfactored surcharge pressures are given by:

$$E_q = \sigma_{hq}$$

where σ_{hq} is the horizontal pressure resulting from any surcharges.

Design surcharge pressures are given by:

$$E_{qd} = \frac{E_q}{f_{Eq}}$$

where f_{Eq} is the appropriate safety factor for the selected design standard (see Chapter 9).

Combined earth pressures

The combined earth pressures (E) from the weight of soil (E_s) and the presence of surcharges (E_q) are given by:

$$E = E_s + E_q$$

If the combined earth pressures are negative and the horizon cannot sustain tension (see the section on *Layers* in Chapter 10), then:

$$E = 0$$

If the design total pressure acting in the horizon on the retained side of the wall is less than the minimum active pressure (P_{\min}^{ret} , see

below), the design earth pressure E_d is increased so that:

$$E_d = P_{\min} - W_d$$

where W_d is the design water pressure acting in the horizon on the retained side of the wall (see below).

Groundwater pressures

Water pressures resulting from pore water pressures in the soil are termed *groundwater pressures* in ReWaRD and given the symbol W_s .

Drained horizons

Groundwater pressures in drained horizons are given by:

$$W_{sd} = W_s = u$$

where u is the pore pressure in the soil.

Undrained horizons

Groundwater pressures in undrained horizons are given by:

$$W_{sd} = W_s = 0$$

Tension cracks

Tension cracks may form on the retained side of the wall when the combined earth pressure E is negative and the horizon cannot sustain tension. Whether an horizon can sustain tension or not depends on the properties of the layer contained in that horizon (see the section on *Layers* in Chapter 10).

Tension cracks may be dry, wet, or flooded (see the section on *Layers* in Chapter 9) and are limited in extent to whatever depth is specified in the selected design standard (see Chapter 9).

Water pressures resulting from tension cracks are termed *tension*

crack pressures in ReWaRD and given the symbol W_{tc} .

Dry tension cracks

In dry tension cracks:

$$W_{tc} = 0$$

Dry tension cracks should only be specified if there is no opportunity for water to collect in any tension crack that forms between the wall and the ground.

Wet tension cracks

In wet tension cracks:

$$W_{tc} = \gamma_w(z - z_{wps})$$

where γ_w is the unit weight of water, z is the depth below ground surface, and z_{wps} is the depth of the phreatic surface (i.e. the depth of the uppermost water table).

Flooded tension cracks

In flooded tension cracks:

$$W_{tc} = \gamma_w z$$

where γ_w and z are as given above. If the uppermost water table is above ground level (in the case of standing water), then:

$$W_{tc} = \gamma_w(z - z_{wps})$$

where z_{wps} is negative in value. Flooded tension cracks give the most pessimistic estimate of tension crack pressures.

Combined water pressures

The combined water pressures (W) from the soil (W_s) and any tension crack (W_{tc}) are given by:

$$W_d = W = \text{maximum of } W_s \text{ and } W_{tc}$$

Total pressures

Design total pressures are given by:

$$P_d = E_d + W_d$$

If, at any depth on the retained side of the wall, the design total pressure is less than the minimum active pressure (see below), then the design earth pressure is increased so that P_d equals P_{\min} .

Minimum active pressures

The *minimum active pressure* (P_{\min}) sets a lower limit to the design total pressure (P_d) acting on the retained side of the wall:

$$P_d \geq P_{\min}$$

(CIRIA Report 104 uses the term *minimum equivalent fluid pressure* – “MEFP” – instead of minimum active pressure.)

The minimum active pressure increases with depth (z) according to the formula:

$$P_{\min} = M z$$

where M is a constant specified by the selected design standard.

Low-propped walls

Research at Imperial College (Nyaoro, 1988) has shown that the earth pressures acting on single-propped retaining walls that are

propped at or near excavation level are different to those assumed in conventional limit equilibrium calculations.

A single-propped wall is considered to be *low-propped* if the overturning moment of the total pressures acting on the wall above the prop (M_{above}) exceeds the restoring moment due to the total pressures acting on the wall below the prop *and above excavation level* (M_{below}).

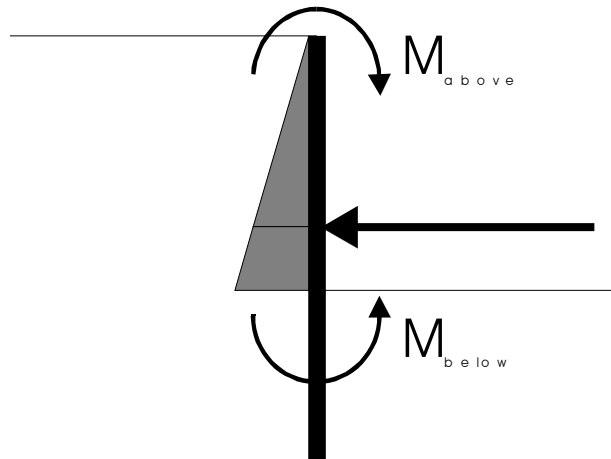

When a wall is low-propped, the wall moves:

- Away from the soil above the prop
- Into the soil below the prop on the retained side of the wall
- Away from the soil below the prop on the excavated side

The corresponding horizontal stresses are calculated using the following earth pressure coefficients:

- Above the prop: active
- Below the prop on the retained side: intermediate between active and passive
- Below the prop on the excavated side: active

Drained horizons

The earth pressure coefficients in drained horizons are given by:

- $K = K_a$ and $K_c = K_{ac}$ above the level of the prop

- $K = K_i$ and $K_c = K_{ic}$ below the level of the prop on the *retained* side
- $K = K_a$ and $K_c = K_{ac}$ below the level of the prop on the *excavated* side

where the subscripts a and i denote *active* and *intermediate* conditions, respectively. K_i and K_{ic} are given by:

$$K_i = K_a + (K_p - K_a) \frac{z_p}{d_p}$$

and

$$K_{ic} = K_{ac} + (-K_{pc} - K_{ac}) \frac{z_p}{d_p}$$

where z_p is the depth below the level of the prop and d_p is the depth of the wall toe below the level of the prop.

When $z_p = 0$, $K_i = K_a$ and $K_{ic} = K_{ac}$. When $z_p = d_p$, $K_i = K_p$ and $K_{ic} = -K_{pc}$. The negative sign in front of K_{pc} ensures that the horizontal effective stress at the toe of the wall equals the full passive pressure, i.e. $\sigma'_{hi} = K_p \sigma'_v - (-K_{pc})c'$.

Values of K_a and K_p are given in the section in this chapter entitled *Earth pressure coefficients*. Formulae for K_{ac} and K_{pc} are given in the section entitled *Stresses in the ground*, under the heading *Horizontal effective stress*.

Undrained horizons

The earth pressure coefficients in undrained horizons are given by:

- $K_u = 1$ and $K_{uc} = K_{auc}$ above the level of the prop
- $K_u = 1$ and $K_u = 1$ and $K_{uc} = K_{iuc}$ below the level of the prop on the *retained* side
- $K_u = 1$ and $K_{uc} = K_{auc}$ below the level of the prop on the *excavated* side

where the subscripts a and i denote *active* and *intermediate* conditions, respectively. K_{iuc} is given by:

$$K_{iuc} = -2 \left(1 - 2 \frac{z_p}{d_p}\right) \sqrt{\left(1 + \frac{a_u}{C_u}\right)}$$

where z_p is the depth below the level of the prop, d_p is the depth of the wall toe below the level of the prop, C_u is the soil's undrained shear strength, and a_u the undrained wall adhesion.

The formula for K_{auc} is given in the section in this chapter entitled *Stresses in the ground*, under the heading *Horizontal total stress*.

Earth pressure coefficients

ReWaRD calculates earth pressure coefficients according to whichever theory is specified in the selected design standard. The earth pressure theories that have been implemented in ReWaRD are those due to:

- Coulomb
- Rankine
- Packshaw
- Caquot & Kerisel
- Kerisel & Absi

Coulomb

Coulomb (1776) developed an earth pressure theory for rigid (i.e. incompressible) soil which fails on a critical, discrete, planar shear surface. Coulomb's work was later extended by Mayniel (1808) and Müller-Breslau (1906).

ReWaRD calculates Coulomb's earth pressure coefficients using the formulae given by Müller-Breslau (1906) for a frictional cohesionless soil with sloping surface and a frictional wall:

$$K_a = \frac{\sin^2 (90^\circ + \phi) \cos \delta}{\sin (90^\circ - \delta) \left[1 + \sqrt{\frac{\sin (\phi + \delta) \sin (\phi - \beta)}{\sin (90^\circ - \delta) \sin (90^\circ + \beta)}} \right]^2}$$

$$K_p = \frac{\sin^2 (90^\circ - \phi) \cos \delta}{\sin (90^\circ + \delta) \left[1 - \sqrt{\frac{\sin (\phi + \delta) \sin (\phi + \beta)}{\sin (90^\circ + \delta) \sin (90^\circ + \beta)}} \right]^2}$$

where ϕ = the soil's angle of friction; δ = the angle of wall friction; and β = the slope of the soil surface (measured positive upwards).

Rankine

Rankine (1857) extended earth pressure theory by deriving a solution for a complete soil mass in a state of failure.

ReWaRD calculates Rankine's earth pressure coefficients using the following formulae:

$$K_a = \cos^2 \beta \frac{\cos \beta - \sqrt{(\cos^2 \beta - \cos^2 \phi)}}{\cos \beta + \sqrt{(\cos^2 \beta - \cos^2 \phi)}}$$

$$K_p = \cos^2 \beta \frac{\cos \beta + \sqrt{(\cos^2 \beta - \cos^2 \phi)}}{\cos \beta - \sqrt{(\cos^2 \beta - \cos^2 \phi)}}$$

where the symbols are as given above for Coulomb's theory.

Rankine's theory assumes that the resultant force on a vertical plane acts parallel to the ground surface, and can only be used when the angle of wall friction (δ) equals the ground slope (β).

The $\cos \delta$ term in these formulae is replaced by $\cos \beta$.

Packshaw

ReWaRD obtains Packshaw's (1946) earth pressure coefficients from a database of values taken from Code of Practice CP2 (1951).

Account is taken of sloping soil surfaces by increasing the value of K_a by 1% for every 1° of inclination above the horizontal (as recommended in the British Steel Piling Handbook, 1997). Since K_{ac} is proportional to the square root of K_a (see the section entitled *Horizontal effective stress* above), it therefore increases by 0.5% for every 1° of inclination.

Caquot & Kerisel

Caquot and Kerisel (1948) derived active and passive earth pressure coefficients using log spiral failure surfaces.

ReWaRD calculates Caquot and Kerisel's active earth pressure coefficients from the following formulae:

$$K_a = \rho K_a^{Coulomb}$$

$$\rho = ([1 - 0.9\lambda^2 - 0.1\lambda^4] [1 - 0.3\lambda^3])^{-n}$$

$$n = (2 - \frac{[\tan^2 \beta + \tan^2 \delta]}{2 \tan^2 \phi}) \sqrt{\sin \phi}$$

$$\Delta = 2 \tan^{-1} \left(\frac{|\cotan \delta| - \sqrt{\cotan^2 \delta - \cotan^2 \phi}}{1 + \operatorname{cosec} \phi} \right)$$

$$\lambda = \frac{\Delta + \beta - \Gamma}{4\phi - 2\pi (\Delta + \beta - \Gamma)}$$

$$\Gamma = \sin^{-1} \left(\frac{\sin \beta}{\sin \phi} \right)$$

where K_a^{Coulomb} is the value of K_a from Coulomb's theory.

ReWaRD obtains Caquot and Kerisel's passive earth pressure coefficients from a database of values taken from Clayton & Milititsky (1986).

Kerisel & Absi

Kerisel and Absi (1990) improved upon the work by Caquot and Kerisel (1948) in deriving active and passive earth pressure coefficients using log spiral failure surfaces.

ReWaRD obtains Kerisel and Absi's passive earth pressure coefficients from a database.

Chapter 3

Required embedment

This chapter gives detailed information about how ReWaRD calculates the required embedment of the wall.

Out-of-balance moment

ReWaRD determines the required embedment of a retaining wall by calculating overturning and restoring moments from the earth pressures acting on it.

The out-of-balance moment (ΔM) is given by:

$$\Delta M = M_R - M_O$$

where M_O is the overturning moment and M_R the restoring moment.

The significance of the out-of-balance moment is as follows:

- If $\Delta M > 0$, the wall is stable
- If $\Delta M = 0$, the wall is in moment equilibrium
- If $\Delta M < 0$, the wall is unstable

Structural forces cannot be calculated for a wall that is not in moment equilibrium.

Cantilever walls

ReWaRD determines the required embedment of cantilever walls under fixed-earth conditions.

Fixed-earth conditions

Under fixed earth conditions, the retaining wall is assumed to rotate about a *pivot* located at some depth (d_o) below excavation level. The earth pressures acting on the wall in this situation are as follows.

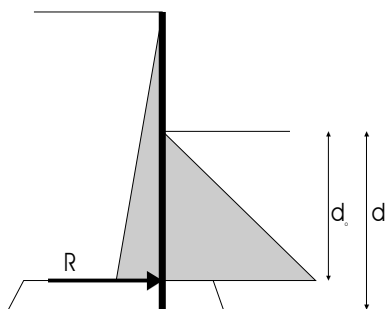

To simplify the analysis, the earth pressures acting below the pivot are replaced by a single resultant force (R). The depth of the pivot below excavation level (d_o) is given by:

$$d_o = \frac{d}{1 + C_d}$$

where d is the total depth of embedment of the wall and C_d is the *cantilever toe-in*. According to CIRIA Report 104 (1984), a conservative value of C_d is 20%.

The embedment needed to achieve equilibrium is determined by taking moments about the pivot and occurs when the sum of the (clockwise) overturning moments equals the sum of the (anti-clockwise) restoring moments. The value of R is found from consideration of horizontal equilibrium.

Single-propped walls

ReWaRD determines the required embedment of single-propped walls under free-earth conditions.

Free-earth conditions

Under free-earth conditions, the retaining wall is assumed to rotate about the level of the support. The earth pressures acting on the wall in this situation are as follows:

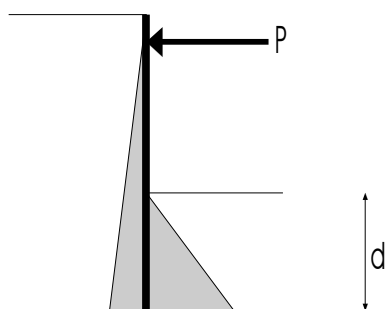

The embedment needed to achieve equilibrium is determined by taking moments about the pivot and occurs when the sum of the (anti-clockwise) overturning moments equals the sum of the (clockwise) restoring moments. The resultant propping force (P) is found from consideration of horizontal equilibrium.

Multi-propped walls

ReWaRD analyses walls with more than one prop using the *hinge method* described in the British Steel Piling Handbook (1997) and BS 8002. In this method, pin joints are introduced at all the support points and the various sections of wall are analysed separately:

- Sections *between* supports are treated as simply-supported beams
- The lowest section is treated as a single-propped cantilever

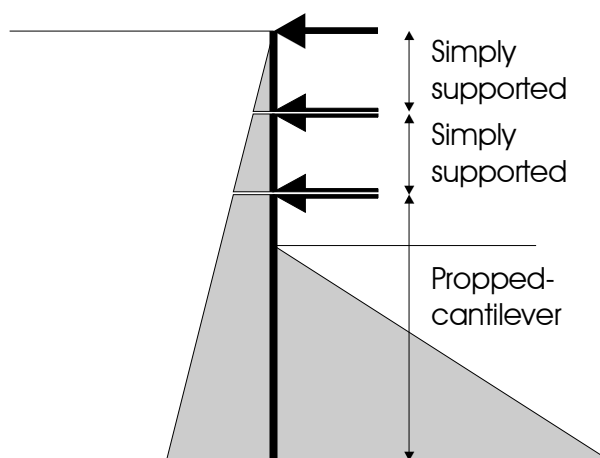

The simply-supported sections of the wall are inherently stable, but the propped cantilever section needs sufficient embedment in the ground to prevent the wall toe from kicking into the excavation.

ReWaRD determines the required embedment of a multi-propped wall from the stability of its propped-cantilever section, using the method described above for single-propped walls.

If the propped-cantilever section is unstable, then ReWaRD treats the wall as simply supported (and hence inherently stable) throughout:

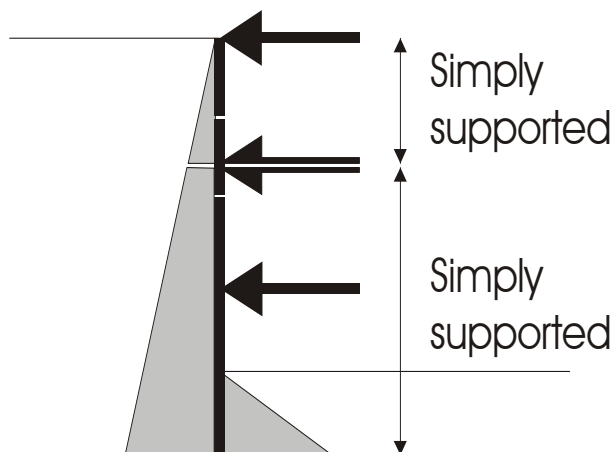

Chapter 4

Structural forces

This chapter gives detailed information about ReWaRD's structural force calculations.

Cantilever and single-propped walls

Before calculating the structural forces acting in a cantilever or single-propped wall, it is necessary to find a set of earth pressures and applied loads that are in force and moment equilibrium. ReWaRD provides three ways of doing this:

- At minimum safe embedment
- With maximum safety factors
- At failure

At minimum safe embedment

In this method, equilibrium is achieved by reducing the depth of embedment of the wall until the earth pressures acting on it are in moment equilibrium. Factors of safety are introduced at appropriate points in the calculations.

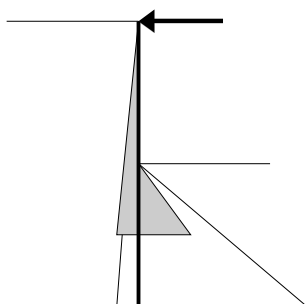

Structural forces calculated by this method are regarded as factored (i.e. design) values (see Chapter 9).

With maximum safety factors

In this method, equilibrium is achieved by increasing the factors of safety introduced into the calculations until the earth pressures acting on the wall are in moment equilibrium. The depth of

embedment of the wall is not reduced.

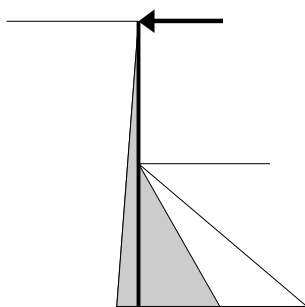

ReWaRD uses the following equation to enhance the safety factors specified in the selected design standard above their normal values:

$$f_{\epsilon} = \epsilon(f - 1) + 1$$

where f is the original safety factor, f_{ϵ} the enhanced safety factor, and ϵ an enhancement factor. This has been specially formulated to ensure that, when $f = 1$, $f_{\epsilon} = 1$ and, when $\epsilon = 1$, $f_{\epsilon} = f$.

Structural forces calculated by this method are regarded as factored (i.e. design) values (see Chapter 9).

At failure

In this method, equilibrium is achieved by reducing the depth of embedment of the wall until the earth pressures acting on it are in moment equilibrium. No factors of safety are applied to any part of the calculations.

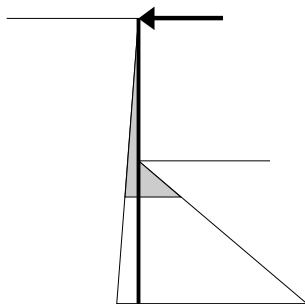

Structural forces calculated by this method are regarded as

unfactored values and need to be multiplied by an appropriate safety factor to obtain design values (see Chapter 9).

This is the recommended method (Method 1) from CIRIA Report 104 (1984).

Multi-propped walls

The structural forces acting in a multi-propped wall are calculated by the *hinge method* described in the British Steel Piling Handbook (1997) and BS 8002. In this method, pin joints are introduced at all the support points and the various sections of wall are analysed separately:

- Sections *between* supports are treated as simply-supported beams
- The lowest section is treated as a single-propped cantilever

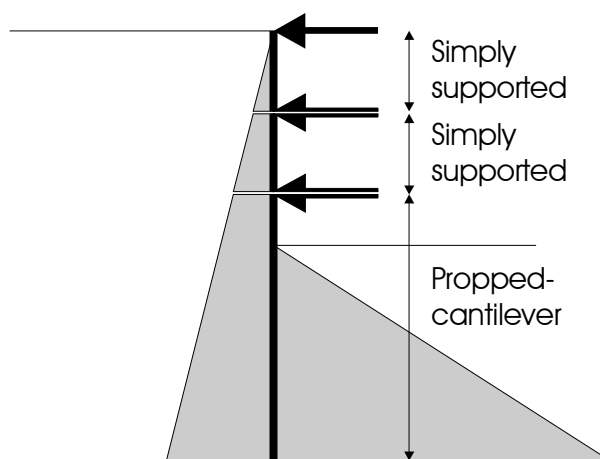

ReWaRD determines the structural forces in propped-cantilever section using one of the methods described above for cantilever and single-propped walls.

A worked example showing how to use this method is given in CIRIA Special Publication 95 (1993).

Design structural forces

Bending moments

Design bending moments (M_d) are given by:

$$M_d = f_M M$$

where M is the unfactored bending moment and f_M is an appropriate safety factor (see Chapter 9).

Shear forces

Design shear forces (S_d) are given by:

$$S_d = f_S S$$

where S is the unfactored shear force and f_S is an appropriate safety factor (see Chapter 9).

Prop forces

Design prop forces (P_d) are given by:

$$P_d = f_P P$$

where P is the unfactored prop force and f_P is an appropriate safety factor (see Chapter 9). Different values of f_P are sometimes used for different props (for double-propped walls, CIRIA 104 recommends a larger f_P for the upper prop than for the lower prop).

Chapter 5

Peck's envelopes

This chapter gives detailed information about ReWaRD's implementation of Peck's envelopes.

Distributed prop loads

Peck's envelopes provide an empirical way of estimating maximum prop loads for multi-propped walls. The envelopes were derived from measurements of strut loads in real excavations and give the *apparent pressure* acting over the retained height of the wall (Peck, 1968).

The term *apparent pressure* has misled some people into thinking that Peck's envelopes represent the actual earth pressures acting on the wall. For this reason, and in anticipation of the publication of CIRIA Report RP526, the term *distributed prop load* is used in ReWaRD instead of apparent pressure.

ReWaRD calculates distributed prop loads for multi-propped walls during short-term stages only. At present, only Peck's original envelopes are implemented in the program. When CIRIA Report RP526 is published, support will be added for the envelopes defined in that report. Refer to ReWaRD's release notes and on-line help for further information.

Peck's envelopes

Peck (1968) introduced envelopes for the following general soil profiles:

- Sand
- Stiff clay
- Soft clay

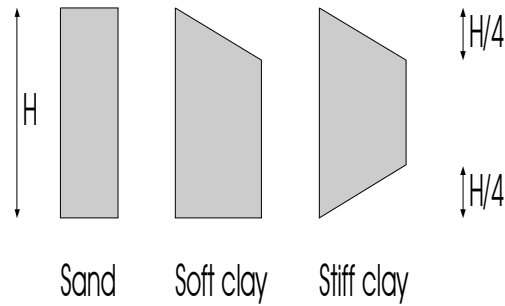

Envelope for sand

Peck's envelope for sand is a rectangle (see the diagram above), with the maximum distributed prop load being given by:

$$DPL_{\max} = 0.65 K_a (\sigma'_{vH} + \sigma_{vqH})$$

where K_a is the average active earth pressure coefficient in any drained horizons existing over the retained height (H); σ'_{vH} is the vertical effective stress at excavation level on the retained side of the wall; and σ_{vqH} is the vertical surcharge at the same point.

Water pressures in the retained soil (when present) are added to the envelope.

Envelope for stiff clay

Peck's envelope for stiff clay is a trapezium (see the diagram above), with the maximum distributed prop load being given by:

$$DPL_{\max} = 0.4 (\sigma_{vH} + \sigma_{vqH})$$

where σ_{vH} is the vertical total stress at excavation level on the retained side of the wall and σ_{vqH} is the vertical surcharge at the same point. (Peck's original envelope – which suggested that DPL_{\max} might be as low as $0.2[\sigma_{vH} + \sigma_{vqH}]$ – is now considered unconservative.)

Peck's envelope for stiff clay includes the effect of any water

pressures acting on the retained side of the wall and hence water pressures are *not* added to the envelope.

Peck's envelope for stiff clay can only be used when the stability number (N) is less than six, as given by:

$$N = \frac{\sigma_{vH} + \sigma_{vqH}}{C_u}$$

where C_u is the average undrained shear strength in any undrained horizons over the retained height.

Envelope for soft to medium clays

Peck's envelope for soft to medium clays is a half-trapezium (see the diagram above), with the maximum distributed prop load being given by one of two formulae:

$$DPL_{\max} = \left(1 - \frac{1.6}{N}\right) (\sigma_{vH} + \sigma_{vqH})$$

$$DPL_{\max} = \left(1 - \frac{4}{N}\right) (\sigma_{vH} + \sigma_{vqH})$$

where the symbols are as defined for the stiff clay envelope.

The first formula is used if the cutting is underlain by a deep deposit of soft clay (i.e. when the thickness of soft clay below excavation level exceeds the retained height), otherwise the second equation is used. In this context, clay is considered soft if its undrained strength is less than 40 kPa.

Peck's envelope for soft to medium clays includes the effect of any water pressures acting on the retained side of the wall and hence water pressures are *not* added to the envelope.

Peck's envelope for soft to medium clays can only be used when the stability number N is greater than four.

Obtaining prop loads from Peck's envelopes

Prop loads are obtained from Peck's envelopes by dividing the distributed prop load (DPL) diagrams into segments at the midpoints between the props. The load in any one prop is then calculated by integrating the DPL over its associated segment.

The following example illustrates this procedure.

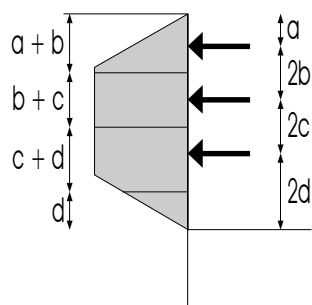

The load carried by the top prop is equal to the area of the first segment, of thickness $a + b$.

The load carried by the middle prop is equal to the area of the second segment, of thickness $b + c$.

The load carried by the bottom prop is equal to the area of the third segment, of thickness $c + d$.

The load represented by the fourth segment is assumed to be carried by the ground below excavation level.

Chapter 6

Base stability

This chapter gives detailed information about ReWaRD's base stability calculations.

Factor-of-safety against basal heave

Bjerrum and Eide (1956) defined the factor-of-safety against basal heave (F_{bh}) as follows:

$$F_{bh} = \frac{N_c C_u}{\sigma_{vH} + \sigma_{vqH}^{ret} - \sigma_{vqH}^{exc}}$$

where N_c is a stability number; C_u is the average undrained shear strength of any undrained horizons within a depth $0.7H$ below excavation level; H is the retained height of the wall; σ_{vqH}^{ret} is the vertical total stress at excavation level on the retained side of the wall; σ_{vqH}^{exc} is the vertical total stress at excavation level on the excavated side of the wall; and σ_{vH} is the vertical surcharge at the same point.

Stability number

The stability number (N_c) is given by:

$$N_c = 9\beta \left(\frac{1 + 0.2B/L}{1.2} \right) \left(\frac{1 + 0.2H/B}{1.5} \right) \text{ for } H/B \leq 2.5$$

$$N_c = 9\beta \left(\frac{1 + 0.2B/L}{1.2} \right) \text{ for } H/B > 2.5$$

where H is the retained height; B is the breadth and L the length of the excavation (see the section on *Excavations* in Chapter 10); and β is the *rigid layer correction* (defined below).

Rigid layer correction

The rigid layer correction (β) is derived from the bearing capacity factors given by Button (1953) and is given by:

$$\beta = 1 + 0.008 \left(\frac{d}{B} \right)^{-1.4}$$

where d is the depth below excavation level to the top of the first rigid layer and B is the breadth of the excavation.

ReWaRD treats a layer as rigid if it is flagged as such (see the section on *Layers* in Chapter 10).

Chapter 7

Displacements

This chapter gives detailed information about ReWaRD's displacement calculations.

ReWaRD estimates the construction-induced (i.e. short-term) movement of the retaining wall – and the settlement of the ground surface behind it – from an extensive database of measured displacements. Long-term movements, which are generally associated with changes in pore water pressure in the soil, are not included in the database but are not usually damaging to the retaining structure. (An exception to this would be in soft clays subject to long-term changes in pore water pressure.)

Displacements depend on a number of factors, of which the most important are the height of the excavation and the prevailing soil type. Dimensionless displacement profiles are used to determine the distribution of movement down and behind the wall.

ReWaRD allows you to view upper bound, average, and lower bound displacements, based on the case histories included in the database.

Displacements are given for sections of wall that deform under plane strain conditions. Sections that are close to the corners of the excavation or close to buttresses, etc., usually displace far less.

Database of wall movements

ReWaRD's database of measured displacements combines the case histories used by Clough and O'Rourke (1992) and St John *et al.* (1992) to determine construction-induced wall movements.

The database is split into three parts, depending on the prevailing soil conditions:

- Sand
- Stiff clay
- Soft clay

In each case, the measured displacements increase with increasing height of excavation (H), as described below.

Surcharge loading factor

The *surcharge loading factor* (f_q) that appears in many of the equations below takes account of the increase in vertical stress that results from the presence of any surcharges acting on the retained side of the wall.

For sand profiles, the surcharge loading factor is given by:

$$f_q = 1 + \frac{\sigma_{vqH}}{\sigma'_{vH}}$$

where σ'_{vH} is the vertical effective stress at excavation level due to the weight of soil and water and σ_{vqH} is the vertical stress at the same point due to any surcharges.

For soft and stiff clay profiles, the surcharge loading factor is given by:

$$f_q = 1 + \frac{\sigma_{vqH}}{\sigma_{vH}}$$

where σ_{vH} is the vertical total stress at excavation level due to the weight of soil and water and σ_{vqH} is as defined above.

Database for sands

The database for sands is taken from Clough and O'Rourke (1992) and includes 7 case histories for excavations up to 24m high.

Cantilever and propped walls

Maximum displacements

The maximum settlement behind the wall (δ_{vm}) is given by:

$$\frac{\delta_{vm}}{H} = (0.003 \pm 0.001) f_q$$

where f_q is the surcharge loading factor (see above). The \pm values represent upper and lower bounds to the data.

The maximum horizontal movement of the wall (δ_{hm}) is given by:

$$\delta_{hm} = \frac{4}{3} \delta_{vm}$$

Displacement profiles

Clough and O'Rourke (1992) proposed an envelope of normalized settlement (δ_v/δ_{vm}) for sands which is triangular and extends for a distance equal to twice the height of the excavation (H).

Closer scrutiny of the data suggests that the bounds to the measured settlements can be defined more closely than Clough and O'Rourke propose. ReWaRD therefore calculates displacements for sands using a modified form of the triangular settlement profile proposed by Clough and O'Rourke, as shown below.

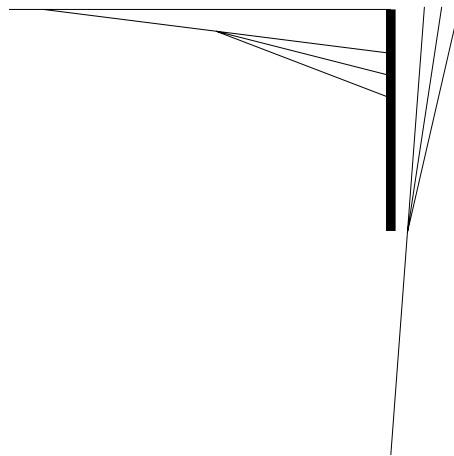

The settlement at $x = H$ (δ_{vH}) is given by:

$$\frac{\delta_{vH}}{H} = 0.001 f_q$$

and the horizontal displacement at $z = H$ (δ_{hH}) is given by:

$$\delta_{hH} = \frac{4}{3} \delta_{vH}$$

The same profiles are used for cantilever and propped walls.

Database for stiff clays

The database for stiff clays is taken from St John *et al.* (1992) and includes 6 case histories involving cantilever excavations up to 8m high and 13 case histories involving propped excavations up to 25m high.

Cantilever walls

Maximum displacements

The maximum horizontal movement (δ_{hm}) of a cantilever wall in stiff clay is given by:

$$\frac{\delta_{hm}}{H} = 0.0015 f_q + (0.00035 \pm 0.00025) f_q^2 H$$

where f_q is the *surcharge loading factor* (see above). The \pm values represent upper and lower bounds to the data.

The maximum settlement (δ_{vm}) behind the wall is given by:

$$\delta_{vm} = 0.75 \delta_{hm}$$

Displacement profiles

Clough and O'Rourke (1992) proposed an envelope of normalized settlement (δ_v/H) for stiff clays which is triangular and extends for a distance equal to three times the height of the excavation (H), as shown below.

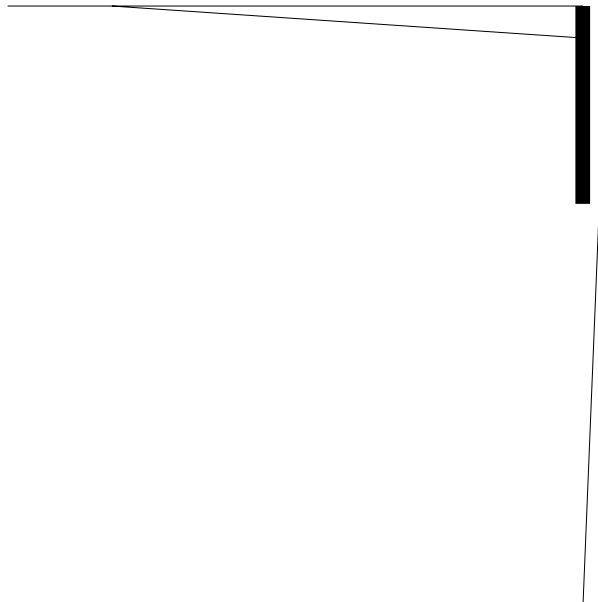

Propped walls

Maximum displacements

The maximum horizontal movement (δ_{hm}) of a propped wall in stiff clay is given by:

$$\frac{\delta_{hm}}{H} = (0.003 \pm 0.001) f_q$$

where f_q is the *surcharge loading factor* (see above). The \pm values represent upper and lower bounds to δ_{hm} .

The maximum settlement (δ_{vm}) behind the wall is given by:

$$\delta_{vm} = 0.75 \delta_{hm}$$

Displacement profiles

As discussed for cantilever walls in stiff clays (above), Clough and O'Rourke (1992) proposed an envelope of normalized settlement (δ_v/H) for stiff clays which is triangular and extends for a distance equal to three times the height of the excavation (H).

St John (1992, personal communication) has found that the maximum settlement behind the wall usually occurs near $x = H$ and that the settlement close to the wall (δ_{v0}) is approximately 50% of δ_{vm} . ReWaRD therefore calculates displacements for propped walls in stiff clays using a modified profile, as shown below.

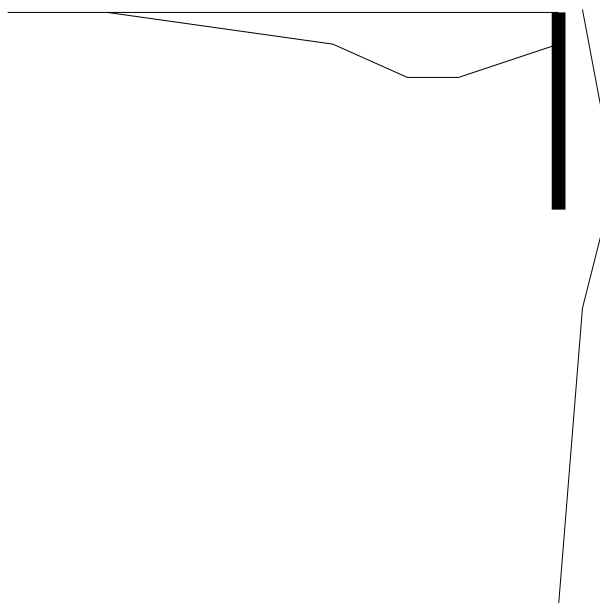

The table below gives the co-ordinates of the key points along these profiles.

| | | | | | |
|-------------------|-----|------|-----|-----|-----|
| x/H or z/H | 0 | 0.65 | 1.0 | 1.5 | 3.0 |
| δ/δ_m | 0.5 | 1.0 | 1.0 | 0.5 | 0.0 |

Database for soft clays

The database for soft clays is taken from Clough and O'Rourke (1992) and includes 13 case histories for excavations up to 20m high.

Cantilever and propped walls

Maximum displacements

According to Clough *et al.* (1989), the horizontal movements of retaining walls in soft clays is controlled by three main factors:

- The height of the excavation (H)
- The factor-of-safety against basal heave (F_{bh} , see Chapter 7)
- The system's stiffness ($EI/\gamma_w s_p^4$, see below)

Clough *et al.* present design curves that allow the maximum horizontal movement of the wall (δ_{hm}) to be estimated from H, F_{bh} , and $EI/\gamma_w s_p^4$ (see below).

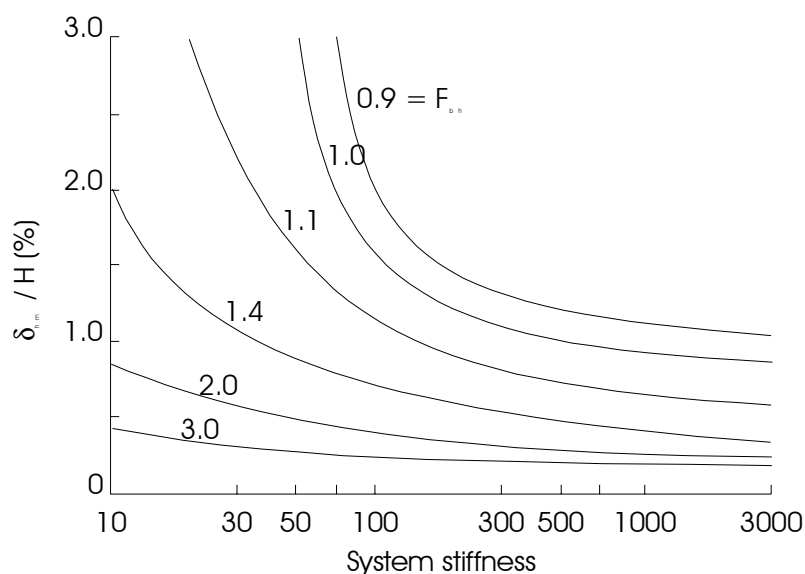

The maximum settlement (δ_{vm}) behind a retaining wall in soft clay is equal in magnitude to its maximum horizontal movement (δ_{hm}) and is given by:

$$\delta_{vm} = \delta_{hm} = f_q \delta_{hm}^{Clough}$$

where δ_{hm}^{Clough} is the maximum horizontal movement obtained from Clough *et al.*'s chart.

Displacement profiles

Clough and O'Rourke propose an envelope of normalized settlement (δ_v/δ_{vm}) for soft clays which is trapezoidal in shape and extends for a distance equal to twice the height of the excavation (H).

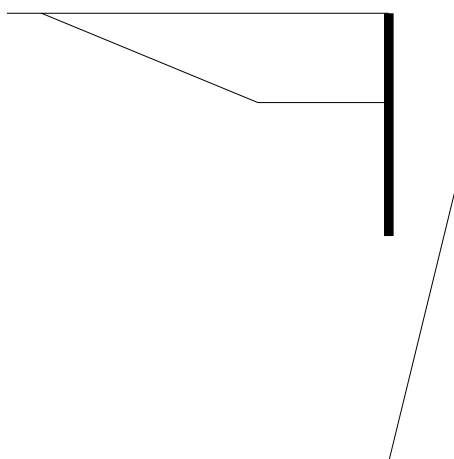

The table below gives the co-ordinates of the key points along these profiles.

| | | | |
|-------------------|-----|------|-----|
| x/H or z/H | 0 | 0.75 | 2.0 |
| δ/δ_m | 1.0 | 1.0 | 0.0 |

The same profiles are used for cantilever and propped walls.

System stiffness

Clough *et al.* (1989) defined *system stiffness* as follows:

$$\text{System stiffness} = \frac{EI}{\gamma_w s_p^4}$$

where E is the Young's modulus of the wall and I its second moment of area; γ_w is the unit weight of water; and s_p is the *average* spacing between props (a value that can only be calculated for multi-propped walls).

Fernie and Suckling (1996) have suggested a method of defining system stiffness for cantilever and single-propped walls:

- For a cantilever: $s_p = \text{retained height} + \text{depth of fixity}$
- For a single-propped wall: $s_p = (\text{retained height below prop} + \text{depth of fixity})$ *or* retained height above prop (whichever is larger)

Fernie and Suckling further suggest that the depth of fixity (d) in soft soils is given by:

- For a cantilever, $d = 1.4H$
- For a single-propped wall: $d = 0.6H$

where H is the retained height.

Chapter 8

Durability

This chapter gives information about ReWaRD's durability calculations.

Corrosion of steel piling in various environments

British Steel's Piling Handbook (1997) gives mean corrosion rates for steel piling in various environments:

| Environment | Description | Mean corrosion rate (mm/year) |
|----------------|---|-------------------------------|
| Atmospheric | Above splash zone | 0.035 |
| Splash zone | 0 to 1.5 m above tidal zone | 0.075 |
| Tidal zone | Between mean high water spring and mean low water neap tides | 0.035 |
| Low water zone | Between mean low water neap and lowest astronomical tide levels | 0.075 |
| Immersion zone | Between lowest astronomical tide and bed level | 0.035 |
| Soil | Below bed level | 0.015 |

ReWaRD calculates the total corrosion rate along a sheet pile wall by summing the mean corrosion rate (taken from the table above) on each side of the wall. For example, a section of wall that is in contact with soil on one side and in the splash zone on the other would have a total corrosion rate of $0.015 + 0.075 = 0.09$ mm/year.

For further information about durability of sheet pile, refer to Chapter 3 of the Piling Handbook.

Chapter 9

Safety factors

This chapter describes the safety factors that ReWaRD uses in its calculation of earth pressures and structural forces.

The following symbols are used throughout this chapter:

E = earth pressure

Subscripts:

a = active mode of failure

d = design (i.e. factored) value

n = nett

nom = nominal value

p = passive mode of failure

r = revised

u = undrained

Superscripts:

ret = retained side of wall

exc = excavated side of wall

Design approaches

CIRIA Report 104 (1984) discusses two distinct approaches to designing embedded retaining walls, based on:

- A. Moderately conservative soil parameters, loads, and geometry
- B. Worst credible soil parameters, loads, and geometry

Lower factors of safety are appropriate when approach B is adopted.

CIRIA 104 recommends different factors of safety for temporary and permanent works, depending on which design approach is adopted. The following table indicates where factors are quoted in the report.

| Design approach | Works | |
|----------------------------|--------------------------------------|--------------------------------------|
| | Temporary | Permanent |
| A. Moderately conservative | ✓ Effective stress * Total stress | ✓ Effective stress ✗ Total stress |
| B. Worst credible | ✓ Effective stress ✗ Total stress | ✓ Effective stress ✗ Total stress |

✓ = values given; * = speculative values given; ✗ = values not given

Safety factors in earth pressure calculations

This section of the *Reference Manual* gives details of the safety factors ReWaRD uses in the earth pressure calculations described in Chapter 2, depending on which design method is adopted:

- Gross pressure method
- Nett pressure method
- Revised (or Burland-Potts) method
- Strength factor method
- Limit state methods

Gross pressure method

In the *gross pressure method* (described in Civil Engineering Code-of-Practice CP2, 1951), a lumped factor-of-safety (F_p) is applied to the gross passive earth pressure:

$$E_{pd} = \frac{E_p}{F_p}$$

Recommended values of F_p taken from the Literature are given below.

| Design standard/approach or reference | | Works | |
|--|----------------------------|--|---|
| | | Temporary | Permanent |
| CP2 | | 2.0 | |
| Teng (1962) | | 1.5-2.0 | |
| <i>Canadian Foundation Engineering Manual (1978)</i> | | 1.5 | |
| CIRIA 104 | A. Moderately conservative | $F_p = 1.2-1.5$ for $\phi = 20-30^\circ$ $F_{pu} = 2.0^*$ | $F_p = 1.5-2.0$ for $\phi = 20-30^\circ$ $F_{pu} = \mathbf{X}$ |
| | B. Worst credible | $F_p = 1.0$ $F_{pu} = \mathbf{X}$ | $F_p = 1.2-1.5$ for $\phi = 20-30^\circ$ $F_{pu} = \mathbf{X}$ |

* = speculative; \mathbf{X} = not given

Burland *et al.* (1981) have criticized the Gross Pressure Method when applied to undrained analysis, because it can lead to two possible required depths of embedment.

Nett pressure method

In the *nett pressure method* (described in the British Steel Piling Handbook, 1997), a lumped factor-of-safety (F_{np}) is applied to the nett passive earth pressure:

$$E_{npd} = \frac{E_{np}}{F_{np}}$$

Recommended values of F_{np} taken from the Literature are given below.

| Design standard | Wall type | |
|-------------------------------|------------|---------|
| | Cantilever | Propped |
| British Steel Piling Handbook | 1.0* | 2.0 |

*According to the Piling Handbook, the safety factor is introduced "by the adoption of reasonably conservative soil strength parameters"

Nett earth pressures are given by whichever of the following equations applies:

$$E_n^{ret} = \sigma_h^{ret} - \sigma_h^{exc} \text{ and } E_n^{exc} = 0 \text{ (when } E_n^{ret} \geq 0 \text{)}$$

or:

$$E_n^{ret} = 0 \text{ and } E_n^{exc} = \sigma_h^{exc} - \sigma_h^{ret} \text{ (when } E_n^{exc} > 0 \text{)}$$

Likewise, nett water pressures are given by:

$$W_n^{ret} = u^{ret} - u^{exc} \text{ and } W_n^{exc} = 0 \text{ (when } W_n^{ret} \geq 0 \text{)}$$

or

$$W_n^{ret} = 0 \text{ and } W_n^{exc} = u^{exc} - u^{ret} \text{ (when } W_n^{exc} > 0 \text{)}$$

The nett pressure method has been criticised for giving rapidly increasing factors-of-safety with increasing depth of embedment, and much higher factors-of-safety than other methods (Burland *et al.*, 1981; Potts & Burland, 1983). Results obtained with the nett pressure method should be compared with those from one or more of the other available methods.

Revised (or Burland-Potts) method

In the *revised (or Burland-Potts) method* (described by Burland *et al.*, 1981), a lumped factor-of-safety (F_r) is applied to the revised passive earth pressures below formation level:

$$E_{rpd} = \frac{E_{rp}}{F_r}$$

Recommended values of F_r taken from the Literature are given below.

| Design standard/approach or reference | | Works | |
|---------------------------------------|----------------------------|--|---|
| | | Temporary | Permanent |
| Burland <i>et al.</i> (1981) | | 1.5-2.0 | |
| CIRIA 104 | A. Moderately conservative | $F_r = 1.3-1.5$ (usually 1.5) $F_{ru} = 2.0$ | $F_r = 1.5-2.0$ (usually 2.0) $F_{ru} = \mathbf{X}$ |
| | B. Worst credible | $F_r = 1.0^*$ $F_{ru} = \mathbf{X}$ | $F_r = 1.5$ $F_{ru} = \mathbf{X}$ |

* = speculative; \mathbf{X} = not given

Drained horizons

Revised active earth pressures in drained horizons *below* excavation level are given by:

$$E_{rak} = (K_a \sigma'_{vH})^{ret}$$

where K_a is the drained active earth pressure coefficient for the horizon on the retained side of the wall and σ'_{vH} is the vertical effective stress on the retained side of the wall at excavation level.

Revised passive earth pressures below excavation level are given by:

$$E_{rpk} = (K_p \sigma'_v + K_{pc} c')^{exc} - (K_a \sigma'_v - K_{ac} c')^{ret} + (K_a \sigma'_{vH})^{ret}$$

where K_p and K_{pc} are the drained passive earth pressure coefficients for the horizon on the excavated side of the wall; K_a and K_{ac} are the drained active earth pressure coefficients for the horizon on the retained side of the wall; and σ'_{vH} is as defined above.

Undrained horizons

Revised active earth pressures in undrained horizons *below* excavation level are given by:

$$E_{rak} = (K_{au} \sigma_{vH})^{ret}$$

where K_{au} is the undrained active earth pressure coefficient for the horizon on the retained side of the wall and σ_{vH} is the vertical total stress on the retained side of the wall at excavation level.

Revised passive earth pressures below excavation level are given by:

$$E_{rpk} = (K_{pu} \sigma_v + K_{puc} C_u)^{exc} - (K_{au} \sigma_v - K_{auc} C_u)^{ret} + (K_{au} \sigma_{vH})^{ret}$$

where K_{pu} and K_{puc} are the undrained passive earth pressure coefficients for the horizon on the excavated side of the wall; K_{au} and K_{auc} are the undrained active earth pressure coefficients for the horizon on the retained side of the wall; and σ_{vH} is as defined above.

Strength factor method

In the *strength factor method* (described in CIRIA Report 104, 1984), a factor-of-safety (F_s) is applied to the soil's coefficient of friction ($\tan \phi$) and effective cohesion (c') and a different factor-of-safety (F_{su}) is applied to its undrained shear strength (C_u):

$$\tan \phi_d = \frac{\tan \phi}{F_s}, c'_d = \frac{c'}{F_s}, C_{ud} = \frac{C_u}{F_{su}}$$

The design earth pressures acting in the ground are then calculated from the design soil parameters:

$$E_d = E = f(\phi_d, c'_d, C_{ud}, \dots)$$

Recommended values of F_s taken from the Literature are given below.

| Design standard/approach | | Works | |
|--------------------------|----------------------------|---|--|
| | | Temporary | Permanent |
| CIRIA 104 | A. Moderately conservative | $F_s = 1.1$ for $\phi > 30^\circ$ else $F_s = 1.2$ $F_{su} = 1.5^*$ | $F_s = 1.2$ for $\phi > 30^\circ$ else $F_s = 1.5$ $F_{su} = \mathbf{X}$ |
| | B. Worst credible | $F_s = 1.0$ $F_{su} = \mathbf{X}$ | $F_s = 1.2$ $F_{su} = \mathbf{X}$ |

* = speculative; \mathbf{X} = not given

Limit state methods

In design standards that employ limit state methods – such as Geoguide 1, BS 8002, and Eurocode 7 – partial factors (γ) are applied at different stages in the earth pressure calculations.

Partial factors are typically applied to:

- Actions (i.e. direct and indirect loads)
- Material properties
- Geometric properties

Partial factors on actions

Design actions (F_d) are obtained from characteristic actions (F_k) by multiplying by the appropriate partial factor (γ_F):

$$F_d = \gamma_F F_k$$

where the value of γ_F varies from one action to another and depends on the selected design standard.

Recommended values of γ_F taken from the Literature are given below.

| Design standard/case | | Action | | | |
|----------------------|----------------|--|------|----------|------------|
| | | Permanent | | Variable | Accidental |
| | | Unfav. | Fav. | | |
| Geoguide 1 | | 1.5 on surcharge on retained side of wall, otherwise 1.0 | | | |
| BS 8002 | | 1.0 | | | |
| Eurocode 7 | A | 1.0 | 0.95 | 1.5 | 1.0 |
| | B | 1.35 | 1.0 | 1.5 | 1.0 |
| | C | 1.0 | 1.0 | 1.3 | 1.0 |
| | Serviceability | 1.0 | 1.0 | 1.0 | 1.0 |

Unfav. = unfavourable; Fav. = favourable

In applying the partial factors from Eurocode 7, pressures arising from the weight of the soil are regarded as unfavourable permanent actions, as are water pressures. Pressures arising from surcharges are regarded as permanent, variable, or accidental and favourable or unfavourable according to which flags are set for each individual surcharge.

Partial factors on material properties

Design material properties (X_d) are obtained from characteristic material properties (X_k) by dividing by the appropriate partial factor (γ_m):

$$X_d = \frac{X_k}{\gamma_m}$$

where different values of γ_m apply to each material property. For soil strength parameters, the specific equations used are:

$$\tan \phi_d = \frac{\tan \phi_k}{\gamma_\phi}, c'_d = \frac{c'_k}{\gamma_c}, c_{ud} = \frac{c_{uk}}{\gamma_{Cu}}$$

where γ_ϕ , γ_c , and γ_{Cu} depend on the selected design standard.

Recommended values of γ_m taken from the Literature are given below.

| Design standard/case | | Partial factor | | |
|----------------------|----------------|----------------|------------|---------------|
| | | γ_ϕ | γ_c | γ_{Cu} |
| Geoguide 1 | | 1.2 | | 2.0 |
| BS 8002 | | 1.2 | | 1.5 |
| Eurocode 7 | A | 1.1 | 1.3 | 1.2 |
| | B | 1.0 | | |
| | C | 1.25 | 1.6 | 1.4 |
| | Serviceability | 1.0 | | |

Partial factors on geometric properties

The design retained height of the wall (H_d) is obtained from the actual retained height (H_k or H_{nom}) by adding an appropriate safety margin (Δ_H):

$$H_d = H_k \pm \Delta_H$$

Recommended values of Δ_H taken from the Literature are given below.

| Design standard/case | | Unplanned excavation (Δ_H) |
|----------------------|----------------|--|
| Geoguide 1 | | None |
| BS 8002 | | 10% of the clear height*, but a <i>minimum</i> of 0.5m |
| Eurocode 7 | A, B, & C | 10% of the clear height*, but a <i>maximum</i> of 0.5m |
| | Serviceability | None |

*For propped walls, clear height = height below bottom prop
For cantilever walls, clear height = height of excavation

Design earth pressures

Design earth pressures acting in the ground are calculated from the design parameters:

$$E_d = E_k = f(F_{d^*}, \phi_{d^*}, c_{d^*}, C_{ud^*}, H_{d^*} \dots)$$

Safety factors for structural forces

This section gives details of the safety factors that are applied to the structural force calculations described in Chapter 4.

At minimum safe embedment

Structural forces calculated at minimum safe embedment (see Chapter 4) are regarded as factored (i.e. design) values.

Bending moments and shear forces

Design bending moments (M) and shear forces (S) are given by:

$$M_d = M \text{ and } S_d = S$$

Prop forces

Design prop forces (P) are given by:

$$P_d = P$$

With maximum safety factors

Structural forces calculated with maximum safety factors (see Chapter 4) are regarded as factored (i.e. design) values.

Bending moments and shear forces

Design bending moments (M) and shear forces (S) are given by:

$$M_d = M \text{ and } S_d = S$$

Prop forces

Design prop forces (P) are given by:

$$P_d = P$$

At failure

Structural forces calculated at failure (see Chapter 4) are regarded as unfactored values and need to be multiplied by an appropriate safety factor to obtain design values. (This is equivalent to the “working stress” approach adopted in many of the older codes of practice and is the method recommended in CIRIA Report 104, 1984.)

Bending moments and shear forces

Design bending moments (M) and shear forces (S) are given by:

$$M_d = f_M M \text{ and } S_d = f_S S$$

Recommended values of f_M and f_S taken from the Literature are given in the table below.

Prop forces

The design prop force (P) for a single-propped wall is given by:

$$P_d = f_p P$$

Recommended values of f_p taken from the Literature are given in the table below.

| Design standard | Safety factor | | |
|-------------------------------|---------------|-------|---|
| | f_M | f_S | f_p |
| CP2 | 1.5 | | $2.0 \times 1.1^* = 2.2$ $2.0 \times 1.15^\dagger = 2.3$ |
| British Steel Piling Handbook | 1.5 | | $2.0 \times 1.15^{*\dagger} = 2.3$ |
| CIRIA 104 | 1.5 | | $2.0 \times 1.25^1 = 2.5$ $2.0 \times 1.15^2 = 2.3$ |

Partial factors to account for arching *in cohesive soils; †in cohesionless soils; ¹in upper level of props; ²in second level of props (single- and double-propped walls only)

Chapter 10

Engineering objects

This chapter gives detailed information about how the various engineering objects in ReWaRD affect its engineering calculations.

Construction stages

Construction stages can be designated as short- or long-term. The term helps determine whether ReWaRD calculates earth pressures using total or effective stress theory (see the section entitled *Total or effective stresses?* in Chapter 2).

Ground profiles

Sloping ground

When calculating earth pressure coefficients for horizons on the retained side of the wall, ReWaRD determines the parameter β that appears in the equations for K_a and K_p (see Chapter 2) as follows:

$$\beta = \max (\beta_{ground}, i_{layer})$$

where β_{ground} is the slope of the ground profile and i_{layer} is the dip of the layer for which earth pressure coefficients are being calculated.

Stepped ground

The effect of a stepped ground profile is to increase the vertical total stress on the retained side of the wall by an amount that varies with depth as shown below.

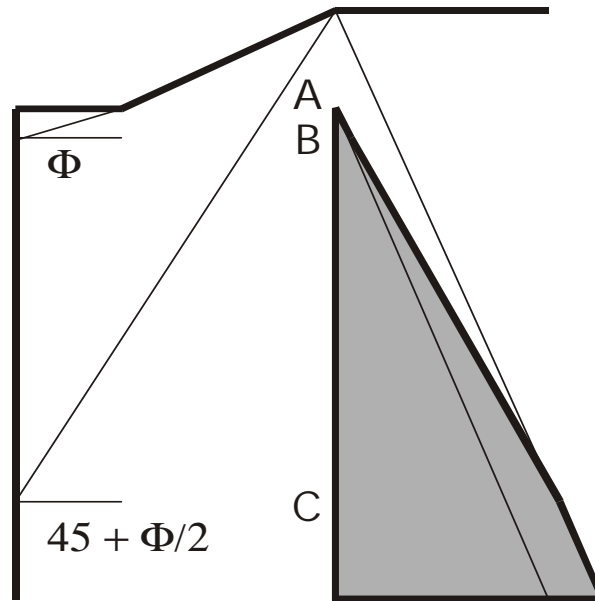

The increase in vertical total stress down the wall ($\Delta\sigma_v$) is given by:

$$\Delta\sigma_v = 0 \text{ for } z_a \leq z \leq z_b$$

$$\Delta\sigma_v = \gamma h \frac{z - z_b}{z_c - z_b} \text{ for } z_b < z < z_c$$

$$\Delta\sigma_v = \gamma h \text{ for } z \geq z_c$$

where γ is the unit weight of soil at the ground surface and the depths z_b and z_c are given by:

$$z_b = f \tan \phi$$

$$z_c = (w + f) \tan \left(45^\circ + \frac{\phi}{2} \right) - h$$

where ϕ is the angle of friction of the soil. In these equations, h is the height, w the width, and f the flat of the stepped ground surface.

This approach is identical to the method (C) recommended in CIRIA Special Publication 95 (1993).

Excavations

Sloping excavations

When calculating earth pressure coefficients for horizons on the excavated side of the wall, ReWaRD determines the parameter β that appears in the equations for K_a and K_p (see Chapter 2) as follows:

$$\beta = \min (\beta_{excavation} - i_{layer})$$

where $\beta_{excavation}$ is the slope of the excavation and i_{layer} is the dip of the layer for which earth pressure coefficients are being calculated.

Berms

ReWaRD calculates the effects of a berm on the earth pressures acting on the excavated side of the wall using the method recommended in CIRIA Special Publication 95 (1993).

The effect of the berm is to increase the vertical total stress on the excavated side of the wall by an amount that varies with depth as shown below.

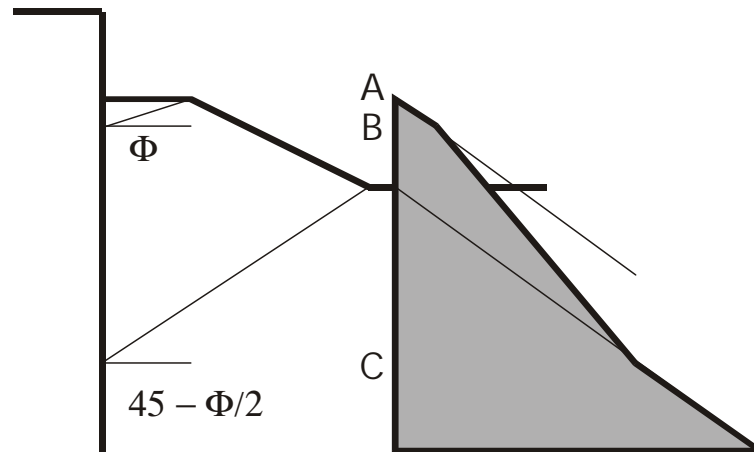

The increase in vertical total stress ($\Delta\sigma_v$) due to the presence of a berm depends on whether it is *wide* or *narrow*.

Narrow berms

A berm is considered narrow when $z_b < h$, in which case $\Delta\sigma_v$ is given by:

$$\Delta\sigma_v = \gamma z \text{ for } z_a \leq z \leq z_b$$

$$\Delta\sigma_v = \frac{\Delta\sigma_v^{\max} (z - z_b) + \gamma(h - z)z_b}{h - z_b} \text{ for } z_b < z < h$$

$$\Delta\sigma_v = \Delta\sigma_v^{\max} \left[\frac{z_c - z}{z_c - h} \right] \text{ for } h \leq z < z_c$$

$$\Delta\sigma_v = 0 \text{ for } z \geq z_c$$

where the largest increase in vertical total stress is:

$$\Delta\sigma_v^{\max} = \gamma h \left(\frac{z_c - h}{z_c - z_b} \right)$$

In these equations, all depths are measured from the top of the berm. γ is the unit weight of soil in the berm and the depths z_b and z_c are given by:

$$z_b = f \tan \phi$$

$$z_c = (w + f) \tan \left(45^\circ - \frac{\phi}{2} \right) + h$$

where ϕ is the angle of friction of the soil and h is the height, w the width, and f the flat of the berm.

Wide berms

A berm is considered wide when $z_b \geq h$, in which case $\Delta\sigma_v$ is given by:

$$\Delta\sigma_v = \gamma z \text{ for } z_a \leq z \leq h$$

$$\Delta\sigma_v = \gamma h \text{ for } h < z \leq z_b$$

$$\Delta\sigma_v = \gamma h \left[\frac{z_c - z}{z_c - z_b} \right] \text{ for } z_b \leq z < z_c$$

$$\Delta\sigma_v = 0 \text{ for } z \geq z_c$$

where the symbols are as given for narrow berms.

Plan dimensions

The plan dimensions of an excavation are used to calculate the factor of safety against basal heave (see Chapter 6).

Soils

Soil classification system

ReWaRD's soil classification system is based on a combination of:

- The British Soil Classification System (BSCS), as described in BS 5930:1981
- The Unified Soil Classification System (USCS), as described in ASTM D2487-1069
- The German Soil Classification System (DIN), as described in DIN 18 196

In addition to the basic groupings of Gravel, Sand, Silt, and Clay that are common to all these systems, ReWaRD's Soil Classification system includes commonly-encountered soils under the headings Organic, Fill, Chalk, Rock, River Soil, and Custom.

The following table lists the soils that are included in ReWaRD's soil classification system and give the corresponding group symbols from each of the established systems listed above (where they are available).

| | Class | Sym- bol | BSCS | USCS | DIN | States |
|--------|----------------|-------------|------|-------|-----|--------------------|
| Gravel | Unclassified* | G | G | G | G | Unspecified (Unsp) |
| | Well-graded | GW | GW | GW | GW | Very loose (VL)† |
| | Uniformly-gr'd | GPu | GPu | GP | GE | Loose (L) |
| | Gap-graded | GPg | GPg | GP | GI | Medium dense (MD) |
| | Silty | G-M | G-M | G?-GM | GU | Dense (D) |
| | Clayey* | G-C | G-C | G?-GC | GT | Very dense (VD) |
| | Very silty* | GM | GM | GM | GU | Poorly comp'd (PC) |
| | Very clayey* | GC | GC | GC | GT | Well comp'd (WC) |

| | Class | Symbol | BSCS | USCS | DIN | States |
|---------------|------------------|--------|-----------|-------|---------------------|---|
| Sand | Unclassified* | S | S | S | S | <i>Same as GRAVEL</i> |
| | Well-graded | SW | SW | SW | SW | |
| | Uniformly-gr'd | SPu | SPu | SP | SE | |
| | Gap-graded | SPg | SPg | SP | SI | |
| | Silty | S-M | S-M | S?-SM | SU | |
| | Clayey* | S-C | S-C | S?-SC | ST | |
| | Very silty* | SM | SM | SM | SU | |
| Very clayey* | SC | SC | SC | ST | | |
| Granular silt | Unclassified | M | M | M | U | Unspecified (Unsp) Very loose (VL)† Loose (L) Medium dense (MD) Dense (D) Very dense (VD) |
| | Gravelly | MG | MG | ML/MH | - | |
| | Sandy | MS | MS | ML/MH | - | |
| | Low-plasticity | ML | ML | ML | UL | |
| Cohesive silt | Unclassified*† | M | M | M | U | <i>Same as CLAY</i> |
| | Int.-plast.*† | MI | MI | ML | UM | |
| | High-plast.*† | MH | MH-ME | MH | - | |
| Clay | Unclassified*†\$ | C | C | C | T | Unspecified (Unsp)*\$ Very soft (VSo) Soft (So) Firm (F)*\$ Stiff (St)*\$ Very stiff (VSt)*\$ Hard (H)*\$ |
| | Gravelly*† | CG | CG | CL/CH | - | |
| | Sandy*† | CS | CS | CL/CH | - | |
| | Low-plast.*† | CL | CL | CL | TL | |
| | Int.-plast.*†\$ | CI | CI | CL | TM | |
| | High-plast.*†\$ | CH | CH-CE | CH | TA | |
| | Laminated*† | Lam | - | - | - | |
| Organic | Unclassified† | O | O | O | O | <i>Same as CLAY</i> |
| | Organic silt† | MO | MLO/ H | OL | (OU) | |
| | Organic clay† | CO | H | OH | OT | |
| | Peat† | Pt | CLO/H | Pt | HN/HZ | |
| | Loam† | Loam | Pt | - | - | |
| Granular fill | Unclassified | MdG | | | | Unspecified Poorly-comp'd (PC) Well-compacted (WC) |
| | Rock fill | RockF | | | | |
| | Slag fill | Slag | | | | |
| | Gravel fill | GravF | | | | |
| | Sand fill | SandF | | | | |
| | Chalk fill | ChkF | | | | |
| | Brick hardcore | Brick | | | | |
| | Ashes | Ash | | | | |
| | PFA | PFA | | | | |
| Clay fill† | ClayF | | | | <i>Same as CLAY</i> | |

| | Class | Sym- bol | BSCS | USCS | DIN | States |
|---|--|---|------|------|-----|--|
| Chalk | Unclassified* Grade I* Grade II* Grade III* Grade IV* Grade V Grade VI | Chk Chk1 Chk2 Chk3 Chk4 Chk5 Chk6 | | | | Unspecified (Unsp) |
| Rock | Marl* Weathered rock* | Marl Rock | | | | Unspecified (Unsp) |
| River soil | River mud† Dock silt† Alluvium† | RivM Dock S Alluv | | | | Unspecified (Unsp) Very soft (VSo) Soft (So) |
| | Custom*†\$ | Cust | | | | Unspecified (Unsp)*\$ |
| G? = G, GW, or GP; S? = S, SW, or SP; Int. = intermediate; plast. = plasticity *may have effective cohesion (if symbol appears next to Class & State) †may be undrained \$may be fissured (if symbol appears next to Class & State) ‡potential for liquefaction | | | | | | |

Database of soil properties

ReWaRD uses a database of soil properties to check that any parameters you enter for a soil are compatible with that soil's engineering description.

ReWaRD's checking system is based on the concept that there are *normal* and *extreme* ranges for each soil parameter.

If you enter a value that is outside the *extreme* range for a particular soil parameter, ReWaRD issues an error message and prevents you from proceeding until you have changed the offending value.

If you enter a value that is outside the *normal* range, ReWaRD issues a warning message and allows you to proceed only if you confirm that the value entered is correct.

The default parameters are provided to assist in initial design studies only, and should not be used as a substitute for measured

parameters. As in all forms of geotechnical design, parameters should be chosen on the basis of adequate site investigation, including suitable laboratory and field measurements.

The publications that have been referred to in compiling the database include:

- Terzaghi & Peck (1967)
- NAVFAC DM-7 (1971)
- Peck, Hanson, & Thornburn (1974)
- Winterkorn & Fang (1975)
- Canadian Foundation Engineering Manual (1978)
- Reynolds & Steedman (1981)
- Bell (1983)
- Mitchell (1983)
- TradeARBED's *Spundwand-Handbuch Teil 1, Grundlagen* (1986)
- Bolton (1986)
- Clayton & Militiski (1986)
- Clayton (1989)
- Tomlinson (1995)
- British Steel's *Piling Handbook* (1997)

Invaluable advice regarding the properties of various soils was provided by Professors JB Burland, PR Vaughan, and DW Hight and by Dr G Sills.

In the following table ρ_d = dry density; ρ_w = wet density; ϕ_{peak} = peak angle of friction; ϕ_{crit} = critical state angle of friction; c'_{peak} = peak effective cohesion; c'_{crit} = critical state effective cohesion; S_u = undrained shear strength; ΔS_u = rate of increase in S_u with depth.

| | Parameter | Classification | | Minimum | | Default | Maximum | |
|--------|-------------------------------|----------------|-------|---------|--------|---------|---------|------|
| | | Class | State | Ext. | Normal | | Normal | Ext. |
| Gravel | ρ_d (kg/m ³) | All | Unsp | 1200 | 1400 | 2050 | 2200 | 2500 |
| | | | VL | 1200 | 1300 | | 1600 | 1800 |
| | | | L | 1300 | 1400 | | 1650 | 2000 |
| | | | MD | 1400 | 1500 | | 1850 | 2200 |
| | | | D | 1500 | 1700 | | 2050 | 2400 |
| | | | VD | 1700 | 2000 | | 2250 | 2500 |
| | | | PC | 1200 | 1400 | | 1650 | 2200 |
| | | | WC | 1400 | 1700 | | 2050 | 2500 |

| | | | | | | | | | | |
|--|-------------------------------|-------------------------------|--|--|--|--|--|--|--|--|
| | ρ_s (kg/m ³) | All | Unsp VL L MD D VD PC WC | 1500 1500 1700 1800 1900 2000 1500 1800 | 1800 1700 1800 1900 2000 2200 1800 2000 | 2200 1850 2000 2100 2200 2250 2000 2200 | 2300 1900 2100 2200 2300 2400 2100 2300 | 2500 2100 2200 2300 2400 2500 2300 2500 | | |
| | ϕ_{peak} (deg) | All | Unsp VL L MD D VD PC WC | 28 28 30 35 40 45 28 35 | 35 32 35 40 45 50 35 45 | 37 34 37 42 47 52 37 47 | 50 38 40 45 50 55 40 50 | 60 40 45 50 55 60 50 60 | | |
| | ϕ_{crit} (deg) | All | All | 28 | 35 | 37 | 40 | 45 | | |
| | c'_{peak} (kPa) | G G_C GM GC | All | 0 | 0 | 0 | 0 | 10 | | |
| | | Others | All | Not applicable | | | | | | |
| | c'_{crit} (kPa) | G G_C GM GC | All | 0 | 0 | 0 | 0 | 5 | | |
| | | Others | All | Not applicable | | | | | | |
| | Sand | ρ_d (kg/m ³) | All | Unsp VL L MD D VD PC WC | 1200 1200 1225 1275 1350 1450 1200 1275 | 1275 1225 1275 1350 1450 1575 1275 1450 | 1675 1450 1500 1575 1675 1800 1500 1675 | 1800 1550 1600 1700 1800 1900 1600 1800 | 2200 1750 1850 1950 2050 2200 1950 2200 | |
| | | | ρ_s (kg/m ³) | All | Unsp VL L MD D VD PC WC | 1600 1600 1750 1800 1850 1950 1600 1800 | 1800 1750 1800 1850 1950 2050 1800 1950 | 2075 1900 1950 1975 2075 2175 1950 2075 | 2150 1975 2000 2050 2150 2250 2000 2150 | 2400 2000 2050 2150 2250 2400 2150 2400 |

| | | | | | | | | |
|---------------|--|----------------------|--------------------------------|----------------------------------|----------------------------------|----------------------------------|----------------------------------|----------------------------------|
| | ϕ_{peak} (deg) | All | Unsp VL | 20 20† | 30 25† | 32 26† | 40 28† | 55 30† |
| | †Reduced to allow for potential liquefaction | | L MD D VD PC WC | 26 29 33 37 23 29 | 30 33 36 40 30 36 | 32 34 37 42 32 37 | 35 37 40 45 35 40 | 40 45 50 55 45 55 |
| | ϕ_{crit} (deg) | All | All | 23 | 30 | 32 | 35 | 40 |
| | c'_{peak} (kPa) discounting natural cementation | S S_C SM SC | All | 0 | 0 | 0 | 0 | 10 |
| | | Others | All | Not applicable | | | | |
| | c'_{crit} (kPa) | S S_C SM SC | All | 0 | 0 | 0 | 0 | 5 |
| | | Others | All | Not applicable | | | | |
| Granular silt | ρ_d (kg/m ³) | All | All | 1100 | 1275 | 1850 | 2150 | 2200 |
| | ρ_s (kg/m ³) | All | All | 1500 | 1800 | 2050 | 2150 | 2400 |
| | ϕ_{peak} (deg) | All | Unsp VL | 20 20† | 27 25† | 28 26† | 33 28† | 45 30† |
| | †Reduced to allow for potential liquefaction | | L MD D VD | 23 25 27 30 | 27 28 29 32 | 28 29 30 33 | 31 32 33 36 | 35 37 40 45 |
| | ϕ_{crit} (deg) | All | All | 20 | 27 | 28 | 31 | 35 |
| | c'_{peak} (kPa) | All | All | 0 | 0 | 0 | 5 | 10 |
| | c'_{crit} (kPa) | All | All | 0 | 0 | 0 | 0 | 5 |
| Cohesive silt | ρ_d (kg/m ³) | All | All | 1100 | 1275 | 1850 | 2150 | 2200 |
| | ρ_s (kg/m ³) | All | All | 1500 | 1800 | 2050 | 2150 | 2400 |
| | ϕ_{peak} (deg) | M MI MH | All | 17 17 17 | 25 25 20 | 28 28 23 | 35 35 30 | 45 40 35 |

| | | | | | | | | |
|----------------------|--|--------|--------|------|------|------|------|------|
| | ϕ_{crit} (deg) | M | All | 17 | 22 | 25 | 30 | 32 |
| | | MI | | 20 | 22 | 25 | 30 | 32 |
| | | MH | | 17 | 18 | 19 | 22 | 25 |
| | c'_{peak} (kPa) | All | VSo-So | 0 | 0 | 0 | 0 | 0 |
| | | | Others | 0 | 0 | 0 | 5 | 10 |
| | c'_{crit} (kPa) | All | VSo-So | 0 | 0 | 0 | 0 | 0 |
| | | | Others | 0 | 0 | 0 | 0 | 5 |
| | C_u (kPa) | All | Unsp | 1 | 20 | 20 | 150 | 1000 |
| VSo | | | 1 | 5 | 10 | 20 | 30 | |
| So | | | 10 | 20 | 25 | 40 | 60 | |
| F | | | 30 | 40 | 50 | 75 | 100 | |
| St | | | 60 | 75 | 100 | 150 | 200 | |
| VSt | | | 100 | 150 | 200 | 300 | 400 | |
| H | | | 200 | 300 | 375 | 500 | 1000 | |
| ΔC_u (kPa/m) | All | VSo-So | -100 | -10 | 0 | 4 | 100 | |
| | | Others | -100 | -10 | 0 | 8 | 100 | |
| Clays | ρ_d (kg/m ³) | All | Unsp | 1200 | 1500 | 2050 | 2200 | 2500 |
| | | | VSo | 1200 | 1400 | 1650 | 1800 | 2000 |
| | | | So | 1300 | 1500 | 1750 | 1900 | 2100 |
| | | | F | 1450 | 1650 | 1900 | 2050 | 2250 |
| | | | St | 1600 | 1800 | 2050 | 2200 | 2400 |
| | | | VSt | 1750 | 1950 | 2200 | 2350 | 2450 |
| | | | H | 1900 | 2100 | 2300 | 2400 | 2500 |
| | ρ_s (kg/m ³) | All | Unsp | 1200 | 1500 | 2050 | 2200 | 2500 |
| | | | VSo | 1200 | 1400 | 1650 | 1800 | 2000 |
| | | | So | 1300 | 1500 | 1750 | 1900 | 2100 |
| | | | F | 1450 | 1650 | 1900 | 2050 | 2250 |
| | | | St | 1600 | 1800 | 2050 | 2200 | 2400 |
| ϕ_{peak} (deg) | C CG CS CL CI CH Lam | All | 15 | 20 | 20 | 33 | 39 | |
| | | | 18 | 20 | 24 | 33 | 39 | |
| | | | 18 | 20 | 24 | 33 | 39 | |
| | | | 20 | 24 | 27 | 33 | 39 | |
| | | | 18 | 20 | 23 | 30 | 37 | |
| | | | 15 | 16 | 20 | 27 | 31 | |
| | | | 15 | 16 | 19 | 25 | 39 | |

| | | | | | | | | |
|---------|-------------------------------|------|--------|------|------|------|------|------|
| | ϕ_{crit} (deg) | C | All | 8 | 20 | 23 | 33 | 39 |
| | | CG | | 18 | 20 | 24 | 33 | 39 |
| | | CS | | 18 | 20 | 24 | 33 | 39 |
| | | CL | | 18 | 20 | 23 | 28 | 30 |
| | | CI | | 18 | 20 | 23 | 28 | 30 |
| | | CH | | 8 | 15 | 18 | 20 | 22 |
| Lam | | | 8 | 12 | 16 | 20 | 22 | |
| | c'_{peak} (kPa) | All | Unsp | 0 | 0 | 0 | 10 | 15 |
| | | | VSo | 0 | 0 | 0 | 0 | 0 |
| So | | | 0 | 0 | 0 | 0 | 0 | |
| | c'_{crit} (kPa) | All | Others | 0 | 0 | 2 | 10 | 15 |
| | | | VSo-So | 0 | 0 | 0 | 0 | 0 |
| | c_u (kPa) | All | Others | 0 | 0 | 0 | 0 | 5 |
| | | | Unsp | 1 | 20 | 20 | 150 | 1000 |
| | ΔC_u (kPa/m) | All | VSo | 1 | 5 | 10 | 20 | 30 |
| | | | So | 10 | 20 | 25 | 40 | 60 |
| | | | F | 30 | 40 | 50 | 75 | 100 |
| | | | St | 60 | 75 | 100 | 150 | 200 |
| | | | VSt | 100 | 150 | 200 | 300 | 400 |
| | | | H | 200 | 300 | 375 | 500 | 1000 |
| | | | | | | | | |
| | ρ_d (kg/m ³) | All | VSo-So | -100 | -10 | 0 | 4 | 100 |
| | | | Others | -100 | -10 | 0 | 8 | 100 |
| Organic | ρ_d (kg/m ³) | Uncl | All | 800 | 1000 | 1500 | 2050 | 2250 |
| | | MO | | 1000 | 1250 | 1500 | 1600 | 1750 |
| | | CO | | 1000 | 1250 | 1500 | 1600 | 1750 |
| Pt | | | 800 | 1000 | 1200 | 1300 | 1400 | |
| Loam | | | 1450 | 1650 | 1900 | 2050 | 2250 | |
| | ρ_s (kg/m ³) | Uncl | All | 850 | 1050 | 1650 | 2050 | 2250 |
| | | MO | | 1400 | 1500 | 1650 | 1750 | 1950 |
| | | CO | | 1400 | 1500 | 1650 | 1750 | 1950 |
| | | Pt | | 850 | 950 | 1250 | 1400 | 1500 |
| | | Loam | | 1450 | 1650 | 1900 | 2050 | 2250 |
| | ϕ_{peak} (deg) | Uncl | All | 18 | 20 | 23 | 30 | 39 |
| | | MO | | 18 | 20 | 23 | 30 | 37 |
| | | CO | | 18 | 20 | 23 | 30 | 37 |
| | | Pt | | 18 | 20 | 23 | 30 | 37 |
| | | Loam | | 20 | 24 | 27 | 33 | 39 |

| | | | | | | | | |
|-------------------------------|-------------------------------|--------------------------------|--|--|---|---|--|---|
| | ϕ_{crit} (deg) | Uncl MO CO Pt Loam | All | 18 18 18 18 20 | 20 20 20 20 24 | 23 23 23 23 27 | 30 30 30 30 33 | 39 37 37 37 39 |
| | c'_{peak} (kPa) | All | All | Not applicable | | | | |
| | c'_{crit} (kPa) | All | All | Not applicable | | | | |
| | C_u (kPa) | All | Unsp VSo So F St VSt H | 1 1 10 30 60 100 200 | 20 5 20 40 75 150 300 | 20 10 25 50 100 200 375 | 150 20 40 75 150 300 500 | 1000 30 60 100 200 400 1000 |
| | ΔC_u (kPa/m) | All | VSo-So | -100 | -10 | 0 | 8 | 100 |
| | | | Others | -100 | -10 | 0 | 8 | 100 |
| Granular fill | ρ_d (kg/m ³) | MdG | All | 600 | 1225 | 1600 | 1800 | 2500 |
| | | RockF | | 1400 | 1500 | 1900 | 2100 | 2200 |
| | | Slag | | 1000 | 1200 | 1450 | 1600 | 1800 |
| GravF | | | 1200 | 1400 | 1950 | 2200 | 2500 | |
| SandF | | | 1200 | 1225 | 1600 | 1800 | 2200 | |
| ChkF | | | 1250 | 1300 | 1350 | 1400 | 1450 | |
| Brick | | | 1100 | 1300 | 1600 | 1750 | 1900 | |
| Ash | | | 600 | 650 | 1000 | 1000 | 1200 | |
| PFA | | | 900 | 1000 | 1350 | 1500 | 1700 | |
| ρ_s (kg/m ³) | | MdG | All | 1200 | 1650 | 2000 | 2150 | 2500 |
| | RockF | | 1750 | 1900 | 2100 | 2200 | 2300 | |
| | Slag | | 1400 | 1700 | 1850 | 1900 | 2000 | |
| | GravF | | 1500 | 1800 | 2150 | 2300 | 2500 | |
| | SandF | | 1600 | 1800 | 2050 | 2150 | 2400 | |
| | ChkF | | 1700 | 1750 | 1825 | 1850 | 1900 | |
| | Brick | | 1400 | 1650 | 1850 | 1950 | 2100 | |
| | Ash | | 1200 | 1300 | 1450 | 1500 | 1800 | |
| | PFA | | 1350 | 1500 | 1750 | 1800 | 2000 | |
| | ϕ_{peak} (deg) | MdG | All | 23 | 30 | 35 | 45 | 60 |
| RockF | | | 35 | 40 | 43 | 50 | 60 | |
| Slag | | | 25 | 30 | 33 | 40 | 50 | |
| GravF | | | 28 | 35 | 40 | 50 | 60 | |
| SandF | | | 23 | 30 | 32 | 35 | 40 | |
| ChkF | | | 25 | 30 | 32 | 37 | 43 | |
| Brick | | | 35 | 40 | 42 | 45 | 50 | |
| Ash | | | 30 | 35 | 37 | 40 | 45 | |
| PFA | | | 27 | 30 | 32 | 37 | 40 | |

| | | | | | | | | |
|---------------|-------------------------------|---|--|--|--|--|--|--|
| | ϕ_{crit} (deg) | MdG RockF Slag GravF SandF ChkF Brick Ash PFA | All | 25 30 25 28 23 25 25 27 27 | 30 35 30 35 30 30 30 30 30 | 32 37 32 37 32 32 32 33 32 | 35 40 35 40 35 35 35 38 35 | 45 45 45 45 40 40 40 42 40 |
| Cohesive fill | ρ_d (kg/m ³) | All | All | 950 | 1100 | 1550 | 1750 | 1900 |
| | ρ_s (kg/m ³) | All | All | 1300 | 1500 | 1850 | 2050 | 2250 |
| | ϕ_{peak} (deg) | All | All | 15 | 17 | 21 | 30 | 35 |
| | ϕ_{crit} (deg) | All | All | 15 | 17 | 21 | 28 | 30 |
| | c'_{peak} (kPa) | All | All | Not applicable | | | | |
| | c'_{crit} (kPa) | All | All | Not applicable | | | | |
| | C_u (kPa) | All | Unsp VSo So F St VSt H | 1 1 10 30 60 100 200 | 20 5 20 40 75 150 300 | 20 10 25 50 100 200 375 | 150 20 40 75 150 300 500 | 1000 30 60 100 200 400 1000 |
| | ΔC_u (kPa/m) | All | VSo-So | -100 | -10 | 0 | 4 | 100 |
| Others | | | -100 | -10 | 0 | 8 | 100 | |
| Chalk | ρ_d (kg/m ³) | Chk | | 1255 | 1275 | 1450 | 2250 | 2500 |
| | | Chk1 | | 1525 | 1650 | 2050 | 2250 | 2500 |
| | | Chk2 | | 1350 | 1400 | 1575 | 1650 | 1725 |
| | | Chk3 | | 1275 | 1325 | 1450 | 1500 | 1550 |
| | | Chk4 | | 1250 | 1300 | 1375 | 1425 | 1475 |
| | | Chk5 | | 1225 | 1275 | 1350 | 1400 | 1450 |
| | | Chk6 | | 1225 | 1275 | 1350 | 1400 | 1450 |
| | ρ_s (kg/m ³) | Chk | | 1725 | 1750 | 1900 | 2450 | 2600 |
| | | Chk1 | | 1925 | 2025 | 2300 | 2450 | 2600 |
| | | Chk2 | | 1800 | 1850 | 1975 | 2025 | 2075 |
| | | Chk3 | | 1750 | 1800 | 1900 | 1925 | 1950 |
| | | Chk4 | | 1750 | 1775 | 1850 | 1875 | 1900 |
| | | Chk5 | | 1725 | 1750 | 1825 | 1850 | 1900 |
| | | Chk6 | | 1725 | 1750 | 1825 | 1850 | 1900 |

| | | | | | | | | |
|------------|-------------------------------|------|-------------------|----------------------|----------------------|----------------------|----------------------|----------------------|
| | ϕ_{peak} (deg) | Chk | | 25 | 30 | 35 | 45 | 55 |
| | | Chk1 | | 25 | 30 | 35 | 45 | 55 |
| | | Chk2 | | 25 | 30 | 34 | 43 | 52 |
| | | Chk3 | | 25 | 30 | 34 | 41 | 49 |
| | | Chk4 | | 25 | 30 | 33 | 39 | 46 |
| | | Chk5 | | 25 | 30 | 32 | 37 | 43 |
| | | Chk6 | | 25 | 30 | 32 | 35 | 40 |
| | ϕ_{crit} (deg) | All | | 25 | 30 | 32 | 35 | 40 |
| | c'_{peak} (kPa) | Chk | | 0 | 0 | 0 | 20 | 100 |
| | | Chk1 | | 0 | 0 | 10 | 20 | 100 |
| | | Chk2 | | 0 | 0 | 5 | 20 | 50 |
| | | Chk3 | | 0 | 0 | 5 | 20 | 50 |
| | | Chk4 | | 0 | 0 | 2 | 10 | 20 |
| | | Chk5 | | 0 | 0 | 0 | 0 | 0 |
| | | Chk6 | | 0 | 0 | 0 | 0 | 0 |
| | c'_{crit} (kPa) | All | | 0 | 0 | 0 | 0 | 5 |
| Rock | ρ_d (kg/m ³) | All | | 2050 | 2100 | 2250 | 2300 | 2500 |
| | ρ_s (kg/m ³) | All | | 2050 | 2100 | 2250 | 2300 | 2500 |
| | ϕ_{peak} (deg) | All | | 27 | 30 | 33 | 38 | 42 |
| | ϕ_{crit} (deg) | All | | 27 | 30 | 33 | 38 | 42 |
| | c'_{peak} (kPa) | All | | 0 | 0 | 5 | 10 | 20 |
| | c'_{crit} (kPa) | All | | 0 | 0 | 0 | 0 | 5 |
| River Soil | ρ_d (kg/m ³) | All | Unsp VSo So | 1200 1200 1200 | 1250 1250 1400 | 1600 1600 1650 | 1800 1800 1800 | 2000 2000 2000 |
| | ρ_s (kg/m ³) | All | Unsp VSo So | 1200 1200 1200 | 1250 1250 1400 | 1600 1600 1650 | 1800 1800 1800 | 2000 2000 2000 |
| | ϕ_{peak} (deg) | All | All | 15 | 16 | 22 | 33 | 39 |
| | ϕ_{crit} (deg) | All | All | 15 | 16 | 22 | 33 | 39 |
| | c'_{peak} (kPa) | All | All | Not applicable | | | | |
| | c'_{crit} (kPa) | All | All | Not applicable | | | | |
| | C_u (kPa) | All | Unsp VSo So | 1 1 10 | 20 5 20 | 20 10 25 | 40 20 40 | 60 30 60 |
| | ΔC_u (kPa/m) | All | All | -100 | -10 | 0 | 4 | 100 |

| | | | | | | | | |
|--------|-------------------------------|------|------|------|------|------|------|------|
| Custom | ρ_d (kg/m ³) | Uncl | Unsp | 600 | 1200 | 2000 | 2400 | 2500 |
| | ρ_s (kg/m ³) | Uncl | Unsp | 850 | 1200 | 2000 | 2400 | 2600 |
| | ϕ_{peak} (deg) | Uncl | Unsp | 10 | 20 | 30 | 50 | 60 |
| | ϕ_{crit} (deg) | Uncl | Unsp | 8 | 20 | 25 | 35 | 45 |
| | c'_{peak} (kPa) | Uncl | Unsp | 0 | 0 | 0 | 10 | 100 |
| | c'_{crit} (kPa) | Uncl | Unsp | 0 | 0 | 0 | 0 | 5 |
| | C_u (kPa) | Uncl | Unsp | 1 | 5 | 20 | 300 | 1000 |
| | ΔC_u (kPa/m) | Uncl | Unsp | -100 | -10 | 0 | 10 | 100 |

Critical state parameters

When calculating earth pressures, ReWaRD applies a partial factor of one to the coefficient of friction and to the effective cohesion of any soil that is flagged as having critical state parameters.

Fissured soils

Soils that are fissured are not allowed any effective cohesion.

Layers

Dip

When calculating earth pressure coefficients, ReWaRD determines the parameter β that appears in the equations for K_a and K_p (see Chapter 2) as follows:

$$\beta^{ret} = \max (\beta_{ground}, i_{layer})$$

$$\beta^{exc} = \min (\beta_{excavation}, -i_{layer})$$

where β^{ret} and β^{exc} are the values of β on the retained and excavated sides of the wall, respectively; β_{ground} is the slope of the ground profile, $\beta_{excavation}$ is the slope of the excavation; and i_{layer} is the dip of the layer for which earth pressure coefficients are being calculated.

Rigid layers

Rigid layers below excavation level can help to increase the factor of safety against basal heave (see Chapter 6). A layer can be considered "rigid" if the ratio of its undrained strength (C_u) to that of the overlying layer (C_u^{over}) is greater than the threshold values given in the following table. In this table, d is the depth to the top of the rigid layer and B is the breadth of the excavation.

| | | | | | |
|------------------|-------|-------|-------|-------|-------|
| d/B | 1 | 0.75 | 0.4 | 0.3 | 0.2 |
| C_u/C_u^{over} | > 1.2 | > 1.5 | > 2.0 | > 2.5 | > 3.0 |

Water tables

Water tables represent changes in the groundwater regime. Each water table affects the groundwater conditions in its underlying horizons. When there are several water tables on one side of the wall, the groundwater conditions in any particular soil horizon are determined by the water table at the top of the horizon or immediately above it.

The type of water table that is present in an horizon determines the pore pressure gradient in that horizon and whether the soil is treated as dry or wet when calculating vertical total stresses (see Chapter 2).

| Water table | Pore pressure gradient (kPa/m) | Soil below is treated as... |
|----------------|--------------------------------|-----------------------------|
| Hydrostatic | 9.80665 | Wet |
| Constant | 0 | Wet |
| Hydrodynamic | User-defined | Wet |
| Linear seepage | Program calculates | Wet |
| Inverted | User-defined | Wet |
| Dry | 0 | Dry |

| Water table | Pore pressure gradient (kPa/m) | Soil below is treated as... |
|-------------|--------------------------------|-----------------------------|
| Standing | 9.80665 | Wet |

Retaining walls

Section properties

The cross-sectional area (A), second moment of area (I), and section modulus (Z) of the various retaining walls ReWaRD supports are determined as follows.

Sheet pile walls

Values of A, I, and Z for Larssen and Frodingham sections are obtained from a database of values supplied by Corus plc.

Secant bored-pile walls

$$A = \left(\frac{D^2}{4S}\right) (\pi + \sin 2\theta - 2\theta)$$

$$I = \left(\frac{D^4}{384S}\right) (6\pi - \sin 4\theta + 8 \sin 2\theta - 12\theta)$$

$$Z = \left(\frac{D^3}{192S}\right) (6\pi - \sin 4\theta + 8 \sin 2\theta - 12\theta)$$

where D and S are the pile's diameter and spacing respectively and $\theta = \cos^{-1}(S/D)$.

Contiguous bored-pile walls

$$A = \frac{\pi D^2}{4S}, I = \frac{\pi D^4}{64S}, Z = \frac{\pi D^3}{32S}$$

where D and S are the pile's diameter and spacing respectively.

King-post (soldier pile) walls

$$A = \frac{\pi D^2}{4S}, I = \frac{\pi D^4}{64S}, Z = \frac{\pi D^3}{32S}$$

where D and S are the pile's diameter and spacing respectively.

Diaphragm walls

$$A = W, I = \frac{W^3}{12}, Z = \frac{W^2}{6}$$

where W is the wall's width.

Rowe's parameter

Rowe's parameter is used as a measure of wall flexibility, to determine the effects of moment redistribution. Rowe's parameter (ρ) is defined as:

$$\rho = \frac{(L - U)^4}{EI}$$

where L is the overall length of the wall; U is the upstand; E is the wall's Young's modulus; and I is its second moment of area (or inertia) *per unit run*.

King-post (or soldier-pile) walls

King-post (or soldier-pile) walls mobilize less passive resistance than continuous walls, owing to their horizontal spacing (S), which in ReWaRD must be greater than or equal to $4.5D$, where D is the diameter of the pile.

Earth pressure coefficients for king-post walls are calculated from Broms' (1965) theory, as follows.

Drained horizons

The passive earth pressure coefficients (K_p and K_{pc}) are calculated as described in Chapter 2 (see the section entitled *Earth pressure coefficients*), and then multiplied by a factor b given by:

$$b = \frac{D}{S}, \text{ for } d < D$$

$$b = \frac{3D}{S}, \text{ for } d \geq D$$

where d is the depth below excavation level, D is the diameter of the pile, and S is the horizontal spacing of the piles.

Undrained horizons

The passive earth pressure coefficients (K_{pu} and K_{puc}) are given by:

$$K_{pu} = K_{puc} = 0, \text{ for } d < 1.5D$$

$$K_{pu} = 1, K_{puc} = \frac{9D}{S}, \text{ for } d \geq 1.5D$$

where d is the depth below excavation level, D is the diameter of the pile, and S is the horizontal spacing of the piles.

Surcharges

Elastic reflection parameter

The *elastic reflection parameter* (e_R) that appears in several of the formulae for surcharge pressures in Chapter 2 takes account of the degree of yielding of the wall:

- If the wall is flexible, $e_R \rightarrow 1$
- If the wall is rigid, $e_R \rightarrow 2$

The doubling of horizontal stress for rigid walls can be explained as follows. In order to obtain zero horizontal displacements along the line of the wall, an imaginary surcharge is needed on the front side of the wall equal in magnitude and position to the real surcharge on the back. The principle of superposition implies that with two surcharges σ_{hq} will be double what it would have been with just one.

The elastic reflection parameter has been found in experiments to vary between 1.0 and 1.5, depending on how rigid the wall is. According to Schmitt & Gilbert (1992), it is common practice in France to use an elastic reflection parameter between 1.5 and 2.0.

The elastic solutions for perpendicular strip and line loads already include an imaginary surcharge on the front of the wall, and hence implicitly assume that $e_R = 2$.

Duration/effect

The duration (Permanent, Variable, or Accidental) and effect (Favourable or Unfavourable) of a surcharge determine the partial factors that are used in the calculation of design pressures for Eurocode 7 (see Chapter 9).

Imposed loads

Duration/effect

The duration of an imposed load (Permanent, Variable, or Accidental) and its effect (Favourable or Unfavourable) determine the partial factors that are used in the calculation of design pressures for Eurocode 7 (see Chapter 9).

Chapter 11

References

Bell FG (1983), *Engineering properties of soils and rocks* (2nd edition), Butterworths, London, 149pp.

Bjerrum L and Eide O (1956), *Stability of structured excavations in clays*, Géotechnique, Vol. 6, No 1, pp32-47.

Bolton M (1986), *The strength and dilatancy of sands*, Géotechnique Vol. 36, No. 1.

British Standards Institution (1994), *British Standard code of practice for Earth retaining structures*, BS 8002:1994, 111pp.

British Steel, General Steels (1988), *Piling handbook*, 6th edition, British Steel plc.

British Steel, Sections Plates and Commercial Steels (1997), *Piling handbook*, 7th edition, British Steel plc.

Broms BB (1965), *Lateral resistance of piles in cohesionless soils*, Proc. Am. Soc. Civ. Engrs, J Soil Mech. Fdn Div., Vol. 90, SM3, pp123-156.

BS 8002. See *British Standards Institution (1994)*.

Burland JB, Potts DM, and Walsh NM (1981), *The overall stability of free and propped cantilever retaining walls*, Ground Engineering, July, 28-38.

Canadian Foundation Engineering Manual. See *Canadian Geotechnical Society (1978)*.

Canadian Geotechnical Society (1978), *Canadian foundation engineering manual*, The Foundations Committee, Canadian Geotechnical Society.

Caquot A and Kerisel J (1948), *Tables for the calculation of passive pressure, active pressure and bearing capacity of foundations*,

Gauthier-Villars, Paris.

Clayton CRI (1989), *The mechanical properties of the Chalk*, Proc. Int. Chalk Symp., Brighton.

Clayton CRI and Militisky J (1986), *Earth pressure and earth-retaining structures*, Surrey University Press, 300pp.

Comité Européen de Normalisation (1994), Eurocode 7: Geotechnical design – Part 1: General rules, Brussels, 126pp.

CIRIA Report 104. See *Padfield and Mair (1984)*.

CIRIA Special Publication 95. See *Williams and Waite (1993)*.

Civil Engineering Code of Practice No 2. See *Institution of Structural Engineers (1951)*.

Clayton CRI and Militiski J (1986), *Earth pressure and earth-retaining structures*, Surrey University Press, Glasgow and London, 300pp.

Clough WG and O'Rourke TD (1990), *Construction induced movements of insitu walls*, Proc. Speciality Conf. on Design and Performance of Earth Retaining Structures, Cornell, ASCE, Geotechnical Special Publication No 25, Lambe PC and Hansen LA (eds), pp439-470.

Clough WG, Smith EM, and Sweeney BP (1989), *Movement control of excavation support systems by interactive design*, Proc. ASCE Found. Engng, Current Principles and Practices, Vol. 2, pp869-884.

Coulomb CA (1776), *Essai sur une application des règles de maximis et minimis à quelques problèmes de statique, relatifs à l'architecture*, Mémoires de Mathématiques et de Physique présentés à l'Académie Royale des Sciences, Paris, 1773, Vol. 7, pp343-382.

Eurocode 7. See *Comité Européen de Normalisation (1994)*.

Fernie R and Suckling T (1996), *Simplified approach for estimating lateral wall movement of embedded walls in UK ground*, in *Geotechnical Aspects of Underground Construction in Soft Ground*,

ed. RJ Mair and RN Taylor, AA Balkema, Rotterdam, pp131-136.

Geoguide 1. See *Geotechnical Control Office (1991)*.

Geotechnical Control Office (1991), *Guide to retaining wall design* (Geoguide 1), 2nd edition, Geotechnical Control Office, Engineering Development Dept, Hong Kong.

Institution of Structural Engineers (1951), *Civil engineering Code of Practice No 2, Earth retaining structures*, Institution of Structural Engineers, London.

Kerisel J and Absi E (1990), *Active and passive earth pressure tables* (3rd edition), AA Balkema, Rotterdam, 220pp.

Liao SSC and Neff TL (1990), *Estimating lateral earth pressures for design of excavation support*, Proc. Speciality Conf. on Design and Performance of Earth Retaining Structures, Cornell, ASCE, Geotechnical Special Publication No 25, Lambe PC and Hansen LA (eds), 489-509.

Mayniel K (1808), *Traité expérimental, analytique et pratique de la poussée des terres et des murs de revêtement*, Paris.

Mitchell (1983), *Earth structures engineering*, Allen & Unwin Inc., Boston.

Müller-Breslau H (1906), *Erddruck auf Stützmauern*, Alfred Kroner, Stuttgart.

NAVFAC DM-7. See *US Dept of the Navy (1982)*.

Nyaoro DL (1989), *Analysis of soil-structure interaction by finite elements*, PhD Thesis, University of London (Imperial College).

Packshaw S (1946), *Earth pressure and earth resistance*, J. Instn of Civ. Engrs, Vol. 25, No 4, 233-256.

Padfield CJ and Mair RJ (1984), *Design of retaining walls embedded in stiff clay*, Report 104, Construction Industry Research and Information Association, London, 146pp.

Pappin JW, Simpson B, Felton PJ, and Raison C (1985), *Numerical analysis of flexible retaining walls*, Proc. Conf. on Numerical Methods in Engineering Theory and Applications, Swansea.

Peck RB, Hanson WE, & Thornburn TH (1974), *Foundation engineering*, John Wiley, New York.

Potts DM and Burland JB (1983), *A parametric study of the stability of embedded earth retaining structures*, Transport and Road Research Laboratory, Supplementary Report SR 813.

Potts DM and Fourie AB (1985), *The effect of wall stiffness on the behaviour of a propped retaining wall*, Géotechnique, Vol. 35, No 3, pp347-352.

Puller M (1996), *Deep excavations – a practical manual*, Thomas Telford Publishing, London, 437pp.

Rankine WJM (1857), *On the stability of loose earth*, Phil. Trans. Roy. Soc., London, Vol. 147, No 2, 9-27.

Reynolds CE and Steedman JC (1981), *Reinforced concrete designer's handbook* (9th edition), Viewpoint Publications, Slough, 505pp.

Rowe PW (1952), *Anchored sheet-pile walls*, Proc. Instn Civ. Engrs, Vol 1., No 1, pp27-70.

Schmitt PJ and Gilbert CM (1992), *Surcharge and elasto-plastic computations of earth retaining structures*, in *Retaining Structures*, Thomas Telford, London, pp56-66.

St John HD, Harris DI, Potts DM, and Fernie R (1992), *Design study for a cantilever bored pile retaining wall with relieving slabs*, Proc. Conf. On Retaining Structures, in *Retaining Structures*, Thomas Telford, London, ppXXX-XXX.

Tamaro GJ and Gould JP (1992), *Analysis and design of cast-in-situ walls (diaphragm walls)*, in *Retaining Structures*, Thomas Telford, London, pp343-352.

- Teng WC (1962), *Foundation design*, Prentice Hall, New Jersey.
- Terzaghi K & Peck RB (1967), *Soil mechanics in engineering practice*, (2nd edition), John Wiley, New York.
- Tomlinson MJ (1995), *Foundation design and construction* (6th edition), Longman Scientific & Technical, Harlow, Essex, 536pp.
- TradeARBED's *Spundwand-Handbuch Teil 1, Grundlagen* (1986)
- US Dept of the Navy (1982), *Design manual: Soil mechanics, foundations and earth structures*, NAVFAC DM-7, US Dept of the Navy, Washington, DC,
- Williams BP and Waite D (1993), *The design and construction of sheet-piled cofferdams*, Construction Industry Research and Information Association, Special Publication 95, Thomas Telford Publications, London, 198pp.
- Winterkorn HF and Fang H-Y (1975), *Foundation engineering handbook*, Van Nostrand Reinhold Co., New York, 751pp.

